



DSView

User Guide

v1.3.0

Revision History

The following table shows the revision history for this document.

Date(DD/MM/YY)	Version	Revision
12/07/23	v1.3.0	release for DSView v1.3.0
02/09/19	v1.0.0	release for DSView v1.0.0
30/05/18	v0.9.9	release for DSView v0.9.9
19/07/17	v0.9.8	release for DSView v0.9.8
08/09/16	v0.9.6	Initial release for DSView v0.9.6

Contents

1	Overview.....	5
1.1	Introduction.....	5
1.2	Download.....	5
1.3	Installing DSView.....	5
1.3.1	Operating System.....	5
1.3.2	Recommended Minimum Hardware.....	5
1.3.3	How to Install.....	6
1.4	User Interface.....	8
1.4.1	Device Mode.....	8
1.4.2	Device Type.....	9
1.4.3	Language Switch.....	10
1.4.4	Theme Switch.....	10
2	Logic Analyzer.....	11
2.1	Hardware Connection.....	11
2.2	Hardware Options.....	13
2.2.1	Mode.....	13
2.2.2	Channel.....	15
2.3	Sample Duration/Rate.....	15
2.3.1	Sample Duration.....	15
2.3.2	Sample Rate.....	16
2.4	Trigger.....	17
2.4.1	Trigger Position.....	17
2.4.2	Simple Trigger.....	18
2.4.3	Advanced Trigger.....	18
2.5	Capture.....	20
2.5.1	Normal Capture.....	21
2.5.2	Instant Capture.....	21
2.5.3	Capture Mode.....	22
2.6	Navigating.....	24
2.6.1	Pan Left/Right.....	25
2.6.2	Zoom in/Out.....	25
2.6.3	Pattern Search.....	26
2.6.4	Channel Customization.....	26
2.7	Measurement.....	27
2.7.1	Width/Period/Frequency/Duty Cycle.....	27
2.7.2	Pulse Counter.....	27
2.7.3	Edge distance.....	28
2.7.4	Cursor Insert.....	28
2.7.5	Cursor Move.....	28
2.7.6	Cursor Jump.....	29
2.7.7	Cursor Measure.....	29
2.7.8	Delete Cursor.....	30

2.8	Protocol Decoder	31
2.8.1	Add Decoder	32
2.8.2	Stack Decoder	33
2.8.3	List Viewer	34
2.8.4	Search Results	34
2.8.5	Export Results	35
2.8.6	Delete Decoder.....	36
2.9	File Operation	36
2.9.1	Load/Save Session	37
2.9.2	Save.....	37
2.9.3	Open.....	37
2.9.4	Export.....	37
2.9.5	Screen Shot	37
3	Oscilloscope.....	38
3.1	Hardware Connection	38
3.2	Hardware Options	39
3.2.1	Operation Mode/Bandwidth Limit.....	39
3.2.2	Auto Calibration.....	40
3.2.3	Manual Calibration	40
3.3	Capture.....	41
3.3.1	Channel Customization.....	41
3.3.2	Horizontal Resolution	42
3.3.3	Run/Stop	43
3.3.4	Single Capture.....	43
3.3.5	Trigger.....	43
3.4	Measurements	45
3.4.1	Auto Measurements	45
3.4.2	Y Cursors	45
3.4.3	X Cursors	48
3.4.4	Manual Measurement.....	48
3.5	Spectrum Analysis	49
3.5.1	FFT Options	49
3.5.2	Navigating Spectrum	50
3.6	Math Function.....	51
3.6.1	Add Math Channel.....	51
3.6.2	Math channel.....	52
3.7	Lissajous Figure.....	53
3.7.1	Lissajous Setup	53
3.7.2	Lissajous View	53
3.8	File Operations.....	54
3.8.1	Load/Save Session	54
3.8.2	Save.....	54
3.8.3	Open.....	54
3.8.4	Export.....	55
3.8.5	Screen Shot	55

4	Data Acquisition.....	56
4.1	Hardware Connection	56
4.2	Hardware Options	56
4.2.1	Operation Mode/ Bandwidth Limit.....	57
4.2.2	Channel Options.....	57
4.3	Capture.....	58
4.3.1	Capture Option.....	58
4.3.2	Start/Stop.....	58
4.4	Measurement.....	58
4.4.1	Cursor Measure	58
4.4.2	Manual Measurement.....	60
4.5	File Operations.....	61
4.5.1	Load/Save Session	61
4.5.2	Save.....	61
4.5.3	Open.....	61
4.5.4	Export.....	62
4.5.5	Screen Shot	62

1 Overview

1.1 Introduction

DSView is a versatile signal capture and analysis software with multiple functions. Its main features include digital logic signal capture and measurement, digital protocol analysis and debugging, real-time display and measurement of analog signals, and signal spectrum analysis, among others.

DSView is also an open source software based on sigrok project (www.sigrok.org), developed and maintained by DreamSourceLab (www.dreamsourcelab.com). Current version (v1.3.0) support three operation modes: Logic Analyzer, Oscilloscope and Data Acquisition.

Currently, DSView supports the following hardware:

- DSLogic series logic analyzer:
 - DSLogic Plus / U3Pro16 / U3Pro32
- DSCope series oscilloscope:
 - DSCope U2P20 / U2B100 / U3P100

1.2 Download

Installer: <http://www.dreamsourcelab.com/download/>

Source code: <http://www.github.com/DreamSourceLab/DSView>

1.3 Installing DSView

1.3.1 Operating System

Windows: Win7 / Win8 / Win10 / Win11

Linux: Debian / Ubuntu, Fedora, OpenSUSE, etc.

Apple: macOS 10.13 and above

1.3.2 Recommended Minimum Hardware

CPU: P4 1.5G or above

Memory: 2G or above

Graphics Memory: 512MB or above

HDD: 20G or above

USB: USB2.0 or above

1.3.3 How to Install

1.3.3.1 Windows



a) *If an earlier version of DSView software is installed, it needs to be completely uninstalled (including drivers)*

b) *For older hardware devices purchased before 2018, if you need to use them on Windows 8 or above, the installation process requires disabling driver signature enforcement. You*

can refer to the following link for instructions:

win8:

<https://learn.sparkfun.com/tutorials/disabling-driver-signature-on-windows-8/disabling-signed-driver-enforcement-on-windows-8>

win10:

https://answers.microsoft.com/en-us/insider/forum/insider_wintp-insider_devices/how-do-i-disable-driver-signature-enforcement-win/a53ec7ca-bdd3-4f39-a3af-3bd92336d248?auth=1

Install Steps:

- 1、 Download the Windows setup file. (<http://www.dreamsourcelab.com/download/>)
- 2、 Double-click on the .exe file to start the installation process.
- 3、 Select installation program language.
- 4、 Click **Next** on welcome page.
- 5、 Please read the license agreement carefully. If you accept the terms of the license agreement and agree to comply with them, click **I Agree** to proceed with the installation. If you do not accept the terms of the license agreement, click **Cancel** to abort the installation. .
- 6、 Choose install location, and click **Install**.
- 7、 Waiting done. If following page appear (Figure 1-1), please select **Install this driver software anyway**.

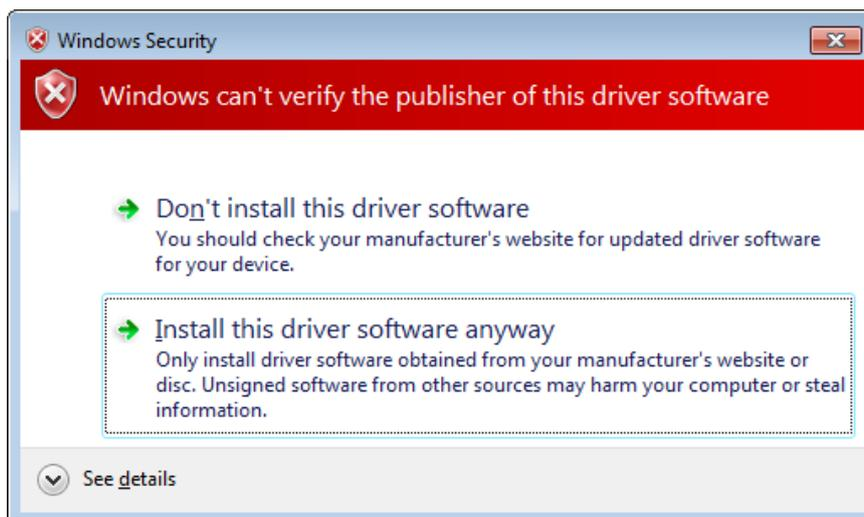

Figure 1-1

1.3.3.2 Linux

Step1: Get the DSView source code

```
$ git clone git://github.com/DreamSourceLab/DSView
```

Step2: Installing the requirements:

please check your respective distro's package manager tool if you use other distros

Debian/Ubuntu:

```
$ sudo apt install git gcc g++ make cmake qt5-default libglib2.0-dev zlib1g-dev \  
libusb-1.0-0-dev libboost-dev libfftw3-dev python3-dev libudev-dev pkg-config
```

How to install qt on ubuntu?

qt5: qt5-default,qtbase5-dev

qt6: qt6-base-dev,libQt6Svg*,libgl1-mesa-dev*

Fedora (18, 19):

```
$ sudo yum install git gcc g++ make cmake libtool pkgconfig glib2-devel \  
zlib-devel libudev-devel libusb1-devel \  
python3-devel qt-devel boost-devel libfftw3-devel
```

Arch:

```
$ pacman -S base-devel git cmake glib2 zlib libusb \  
python boost qt5 fftw
```

Step3: Building

```
$ cmake .
```

```
$ make
```

```
$ sudo make install
```

1.3.3.3 macOS

- 1、 Download the dmg file. (<http://www.dreamsourcelab.com/download/>)
- 2、 Open the dmg, and drag DSView to Application directly.

1.4 User Interface

1.4.1 Device Mode

Figure 1-2 shows the user interface of DSView under logic analyzer mode. Currently, only the DSLogic series logic analyzers support this Device Mode.

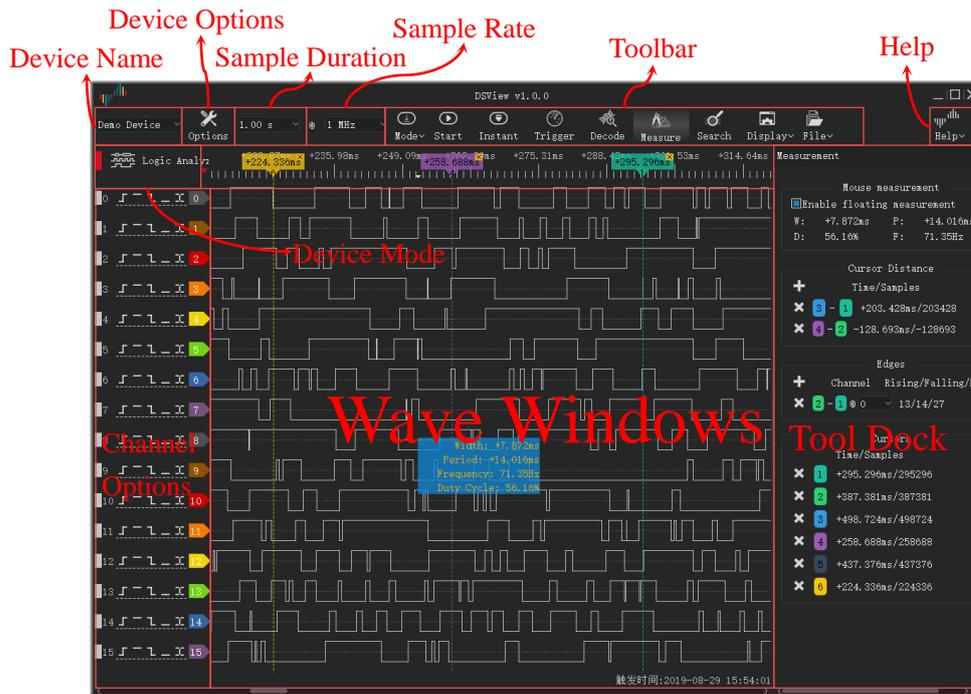

Figure 1-2

Figure 1-3 shows the user interface of DSView under oscilloscope mode. Currently, only the DSCope series oscilloscopes support this Device Mode.

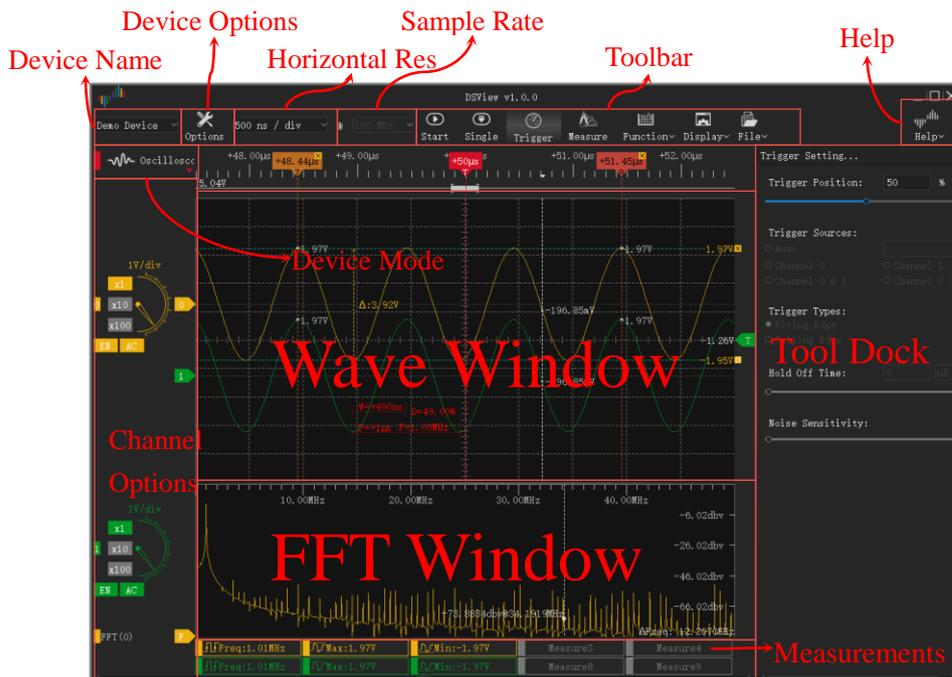

Figure 1-3

Figure 1-4 shows the user interface of DSView under Data Acquisition mode. Currently, only the DScope series oscilloscopes support this Device Mode.

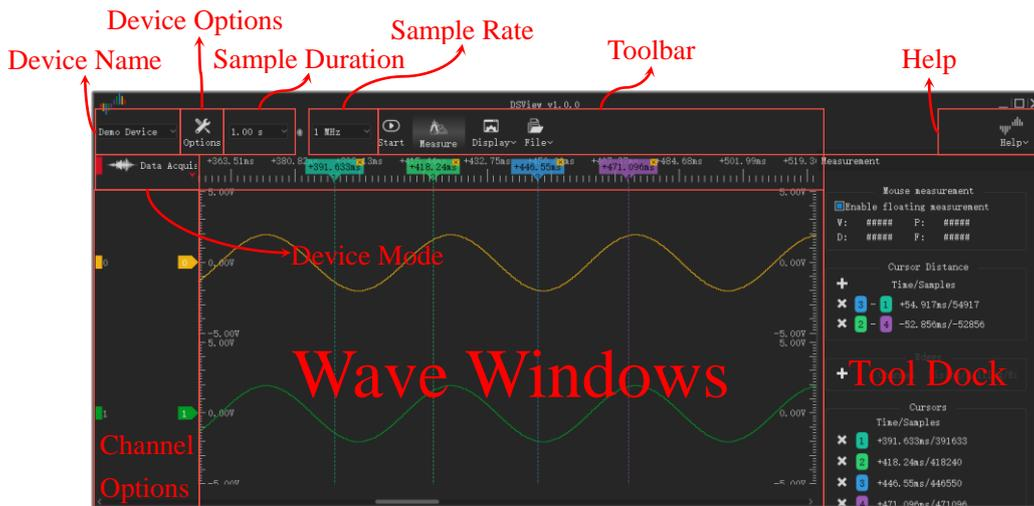

Figure 1-4

1.4.2 Device Type

The leftmost section of the DSView toolbar displays the device type of the current device, as shown in Figure 1-5. DSView has a total of four device types, namely USB 2.0, USB 3.0, Demo Device, and File.

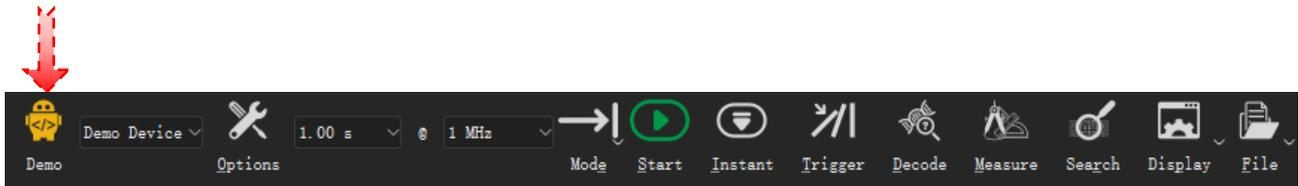

Figure 1-5



Demo: Indicates that the current device is a demo device. This device type is used to demonstrate the functionality of different device modes.



USB 3.0: Indicates that the current device is using a USB 3.0 interface for data transfer.



USB 2.0: Indicates that the current device is using a USB 2.0 interface for data transfer. If the device supports USB 3.0, it is recommended to use a USB 3.0 interface for optimal USB connection quality.

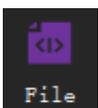

File: Indicates that the current operation involves reading a DSL file and displaying the file data.

1.4.3 Language Switch

Figure 1-6 shows how to switch the UI language. Help→Language →中文 / English.

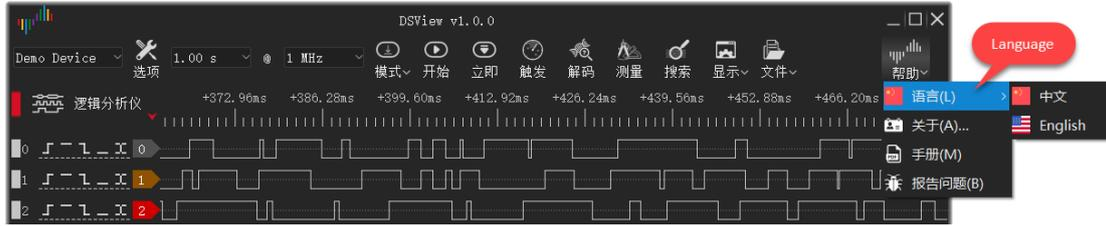

Figure 1-6

1.4.4 Theme Switch

Figure 1-7 shows how to switch the UI theme. Display→Themes →light / dark.

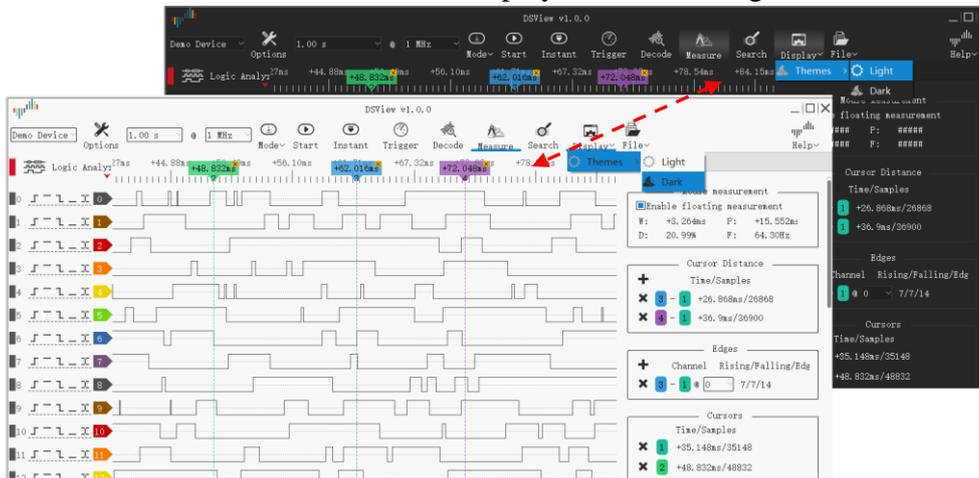

Figure 1-7

2 Logic Analyzer

2.1 Hardware Connection

- 1) Connect the DSLogic to the USB port of the PC using a USB data cable. If the DSView software is not running, the hardware indicator light should be **red**.



Please use the original or a high-quality and short USB data cable, and connect it directly to the USB port on the motherboard. Try to avoid using hub extension ports or front panel ports on the computer case to ensure the best USB connection quality.

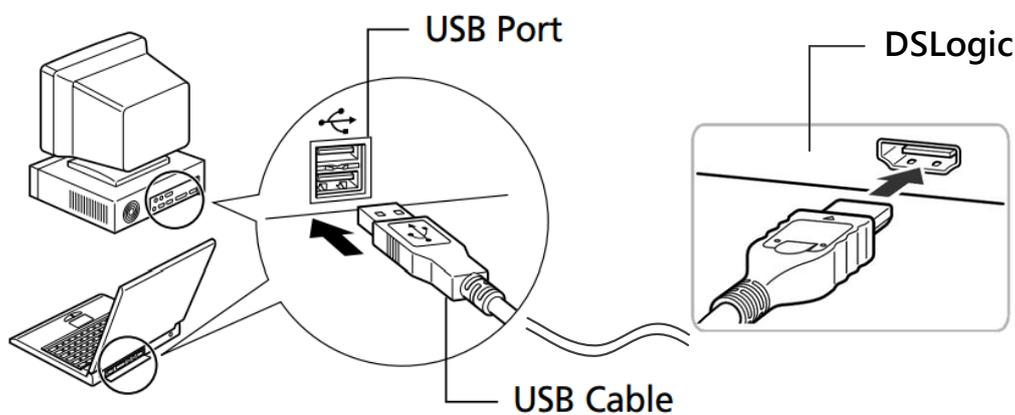

Figure 2-1

- 2) Open the DSView software (the system may need to search for drivers for the first time on Windows, please wait patiently). Confirm that the hardware indicator light turns **green**, the DSView software has successfully recognized the device and displays the correct device name in the device combobox.

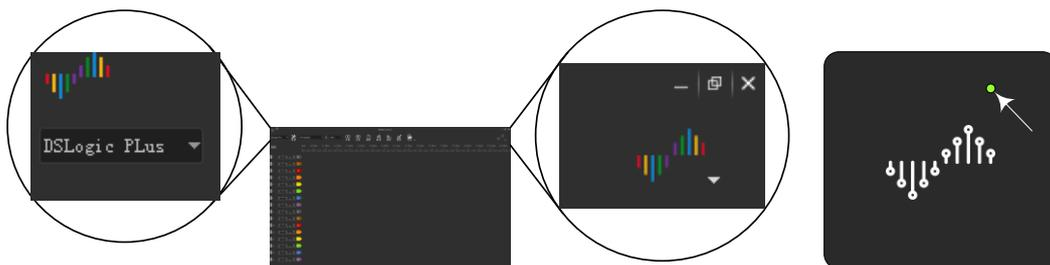

Figure 2-2

- 3) Connect the fly wires to the sampling ports of the logic analyzer. Figure 2-3 shows the correspondence between the fly wires and the channels. Each channel has a shielded fly wire that is divided into signal and ground ports at the end. The colored wires correspond to channels 0-15. Additionally, one fly wire includes CK, TI, and TO signals, which are generally not required to be connected. The CK channel serves as the clock input for state sampling, allowing an external clock to be used as the sampling clock. TI is the input for an external trigger signal, and TO is the output for the trigger signal, which generates a pulse when the triggering condition is met during the sampling process.

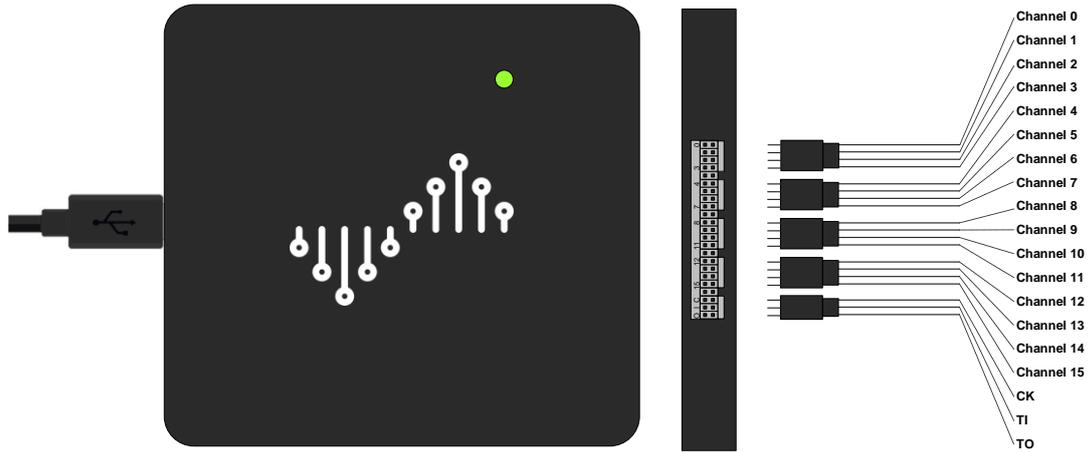

Figure 2-3

- 4) Based on the measurement requirements, connect the channels to the signals to be measured. For low-frequency signals (<5MHz), you can connect the signal under test and a common ground signal (Figure 2-4 left). For high-frequency signals, it is recommended to individually ground each channel to achieve optimal signal integrity (Figure 2-4 right).

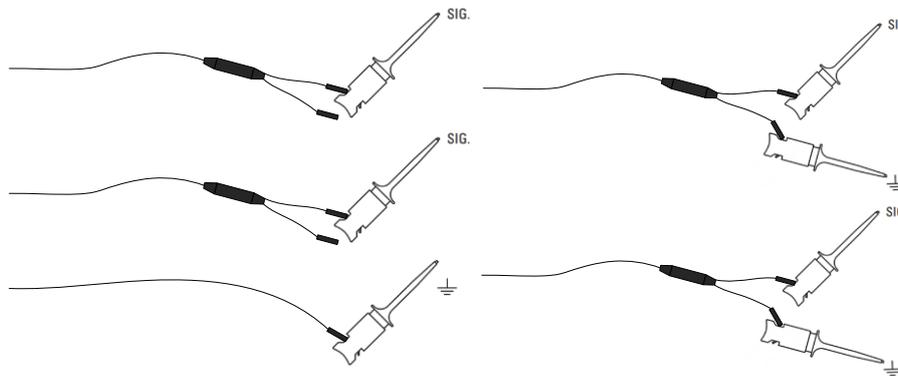

Figure 2-4

2.2 Hardware Options

Click **Options** button (Figure 2-5) or press the shortcut key "O":

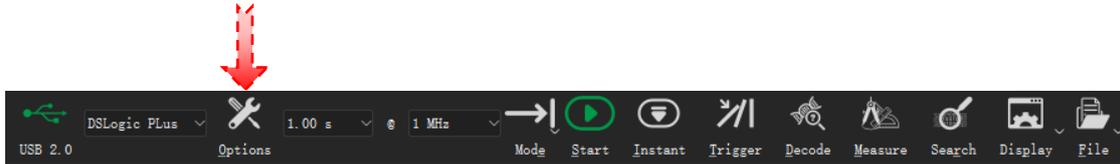

Figure 2-5

Device Options window will be opened. (Figure 2-6). And the specific content of the device options window will vary depending on the hardware device.

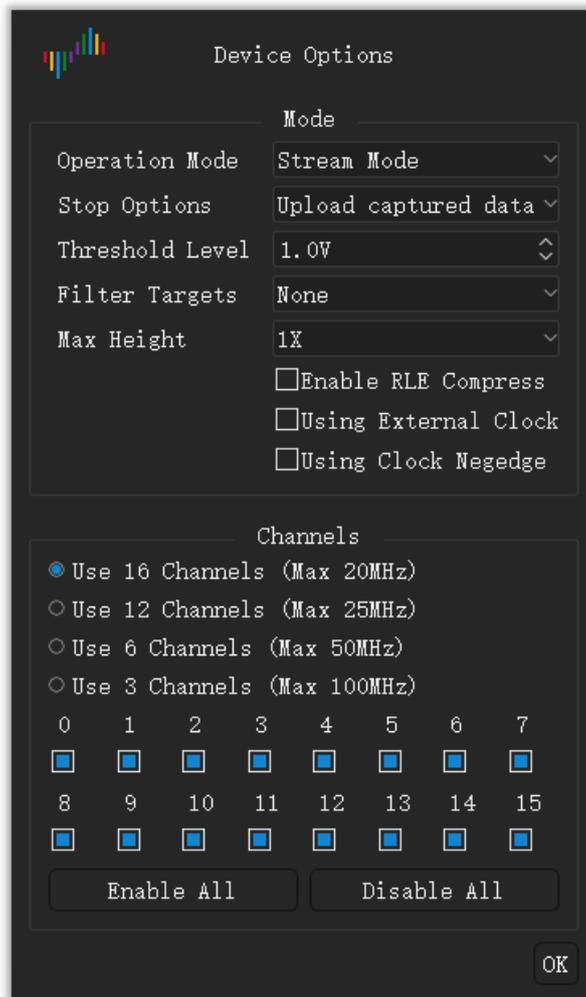

Figure 2-6

2.2.1 Mode

- **Operation Mode:**

- **Buffer Mode:** During the capture process, DSLogic stores the collected data in its hardware memory and transfers the collected data to the PC via USB after the capture is completed.

Due to the higher memory bandwidth compared to USB bandwidth, this mode supports higher Sample Rate. However, it is limited by the memory capacity and does not support longer Sample Duration. This

mode is suitable when the signal frequency is high and there is no need for long-duration data capture.

- **Stream Mode:** During the capture process, DSLogic transfers the collected data to the PC in real-time.

In this mode, there is no need to store the collected data in the hardware memory. Therefore, it supports longer Sample Duration. You can also observe the collected data in real-time. However, it is limited by the USB bandwidth, so it does not support higher Sample Rate. This mode is suitable when the signal frequency is low and there is a need for long-duration data capture.

- **Internal Test:** Test only.

- **Stop Options:**

- **Stop immediately:** In Buffer Mode, when the capture process is stopped, there will be no data upload or display. This option is only applicable in Buffer Mode.

- **Upload captured data:** In Buffer Mode, when the capture process is stopped, the data that has been captured in the hardware memory will be uploaded. Once the data transfer is complete, the software will display this data in the wave window. This option is only applicable in Buffer Mode.

- **Threshold Voltage:**

The threshold voltage is the decision level for digital signals. Signals higher than this voltage are considered as high level, and signals lower than this voltage are considered as low level. The threshold voltage can be set in the range of 0 to 5V with a step size of 0.1V. This setting greatly enhances the compatibility of the logic analyzer with different voltage standards. The specific threshold value can be set according to the voltage standard of the signal being measured. For example, if you are capturing a 3.3V signal, the threshold voltage is generally set around 1.6V.

- **Filter Targets:**

- None: Original capture result
- 1 Sample Clock: filter all pulse less than 1 sampling clock cycle.

- **Max Height:**

Set the maximum height of the signal for each channel in the display area. 1x represents one unit height. This option is used to adjust the display effect when there are fewer channels to be displayed.

- **Enable RLE Compress:**

Selecting this option enables RLE hardware compression. RLE is used to compensate for the limited sample depth in Buffer Mode. When RLE hardware compression is enabled, if there are fewer signal edges, data can be compressed to capture more data. This option is only applicable in Buffer Mode.

- **Using External Clock:**

Selecting this option indicates that the sampling clock is provided externally (via the CK channel of the cable).

- **Using Clock Negedge:**

By default, the system samples on the rising edge of the sampling clock. Selecting this option indicates that the system will sample on the falling edge of the sampling clock.

2.2.2 Channel

- **Channel Mode:**

The channel mode determines the actual number of channels used during the capture process. Different channel modes allow for different maximum sample rates. Select the appropriate channel mode based on the frequency and the number of signals being measured.

- **In Buffer Mode**

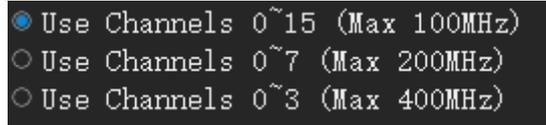

Figure 2-7

In Buffer Mode, there are channel modes available that support higher maximum Sample Rate. Figure 2-7 shows the channel modes that can be selected for DSLogic Plus in Buffer Mode.

- **In Stream Mode**

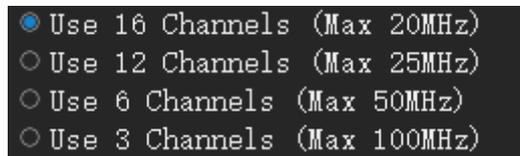

Figure 2-8

In Stream Mode, there are channel modes available that support lower maximum Sample Rate. Figure 2-8 shows the channel modes that can be selected for DSLogic Plus in Stream Mode.

- **Channel Enable:**

After Channel Mode set, each available channel can be enabled or disabled. **Enable All** will enable all available channels; otherwise, **Disable All** will disable all available channels.

2.3 Sample Duration/Rate

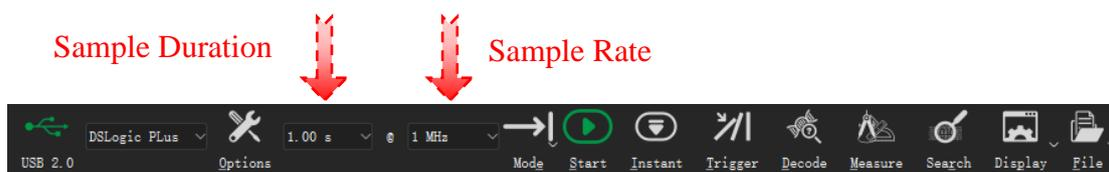

Figure 2-9

2.3.1 Sample Duration

As Figure 2-9 shows, the first combobox represents the Sample Duration. Under different Capture Mode/Sample Rate/Channel Mode configurations, the Sample Duration has different ranges.

- **Buffer Mode:** Max Duration = Hardware Depth / Sample Rate / Channel Number. For example, DSLogic Plus device has 256Mbits hardware memory, so @100M 16channels, the max Sample Duration will be about 167.77ms; @400M 1channel, the Sample Duration will be about 671.09ms.
- **Stream Mode:** Max duration (64bit software) = 16G / Sample Rate. For example, @1MHz Sample Rate, the max Sample Duration will be about 4.77 hours; @100MHz Sample Rate, the max Sample Duration will be about 2.86 minutes.

2.3.2 Sample Rate

As Figure 2-9 shows, the second combobox represents the Sample Rate per channel. The supported Sample Rate varies depending on the device, USB interface, operating mode, and channel mode.

In general, the sample rate should be set to 4-10 times the highest frequency of the signal being measured. A 4x sampling rate can capture every edge of the measured signal, but with a low phase accuracy of only +/- 25%, which means only 4 points are captured per cycle of the measured signal.

As shown in Figure 2-10, the same signal will be sampled differently at different sampling rates. When the sample rate is too low, the original signal cannot be accurately reconstructed. According to the sampling principle, the highest accuracy in any sample rate is within a sample interval. For example, using a sample rate of 100MHz, the accuracy range for each edge captured is within +/- 10ns. Therefore, under normal circumstances, if phase accuracy is required, it is generally recommended to use a sample rate of at least 10 times or higher than the highest frequency of the signal being measured. For example, for sampling a UART signal with a baud rate of 115200, the sample rate is usually set to 2MHz, and for sampling a SPI signal at 40MHz, the sample rate can be set to 400MHz.

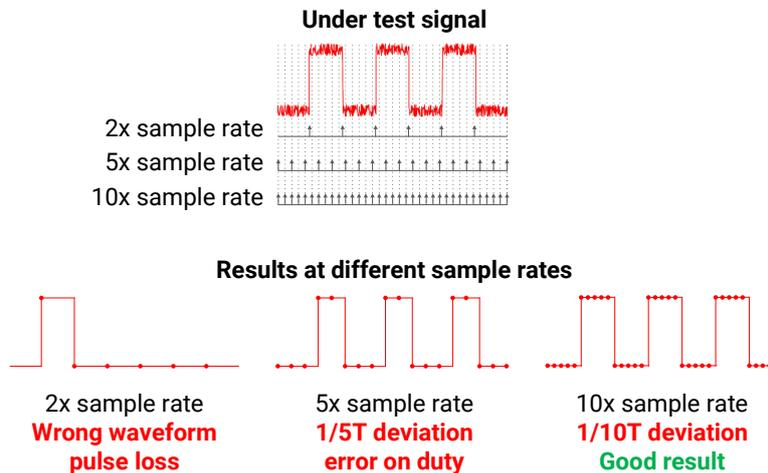

Figure 2-10

In general, the higher the sample rate, the higher the resolution of the sampled results and the closer they are to the true signal. However, it is not necessary to use the highest sampling rate for every signal, and there are two main factors to consider:

1. The higher the sample rate, the more data is generated per unit of time, resulting in a shorter total acquisition time. Additionally, processing signals of the same duration in software will also take more time.
2. When the frequency of the measured signal is very low, it often means that the rising/falling time is longer. As shown in Figure 2-11, excessively high sampling rates may capture the transitions and glitches of the rising/falling edge itself, which can be detrimental to signal or protocol analysis.

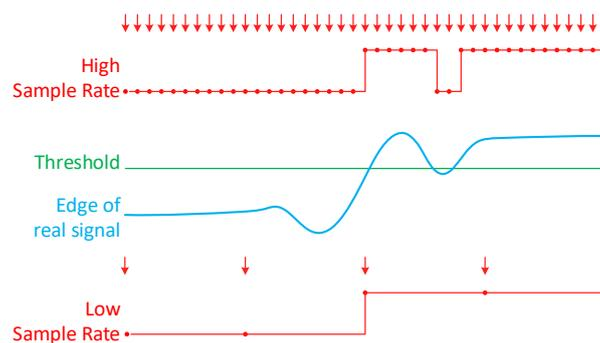

Figure 2-11

2.4 Trigger



When setting up triggering, it is necessary to ensure that the trigger conditions are correctly configured and that the waveform meets the trigger conditions. Otherwise, the sampling process will wait indefinitely as it cannot trigger correctly.

Trigger is one of the most important features of a logic analyzer as it helps us capture specific moments of the signal that we want to observe. DSView supports two trigger modes: Simple Trigger and Advanced Trigger.

Click **Trigger** button or press the shortcut key "T", trigger dock will be open (Figure 2-12).

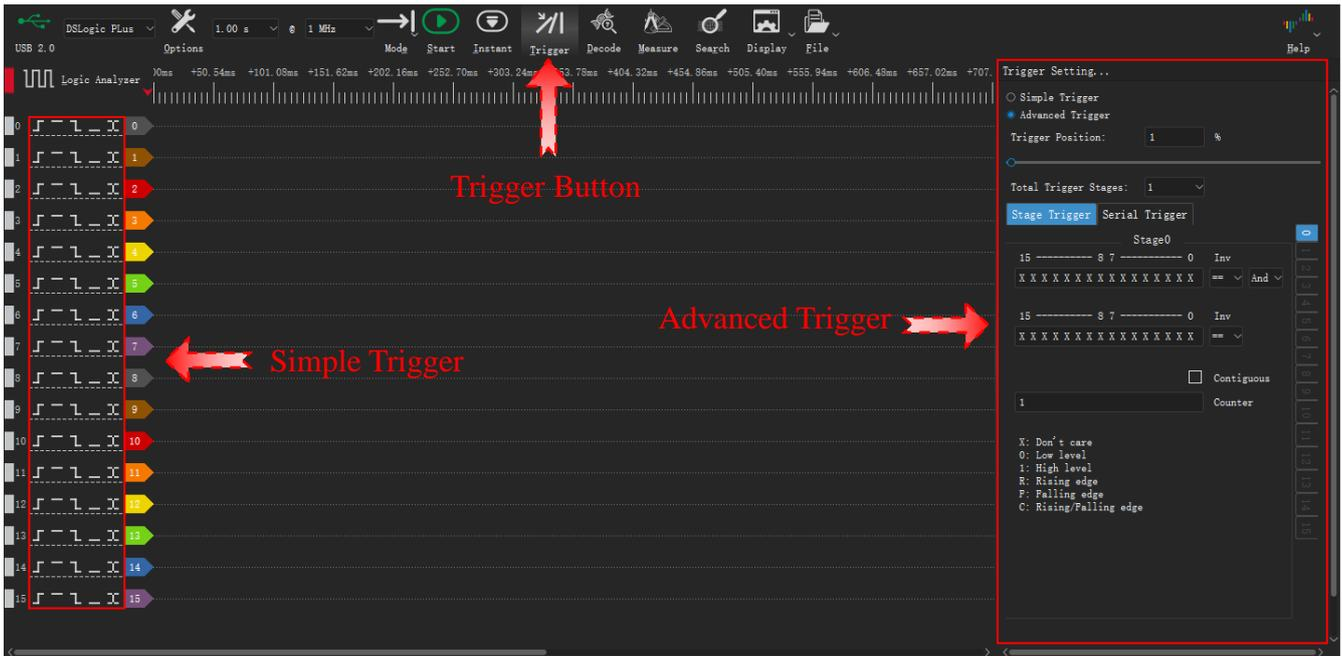

Figure 2-12

2.4.1 Trigger Position

The trigger position is set as a percentage of the sample duration to locate the trigger point. Setting the appropriate position helps locate problem waveforms. As shown in Figure 2-13, the left diagram shows a trigger position of 10%, while the right diagram shows a trigger position of 90%.

To observe waveforms after the trigger event, set the trigger position earlier. To observe waveforms before the trigger event, set the trigger position later.

Note: The trigger position requires hardware memory and is only available in buffer mode. In stream mode, the trigger position is typically fixed at 1%.

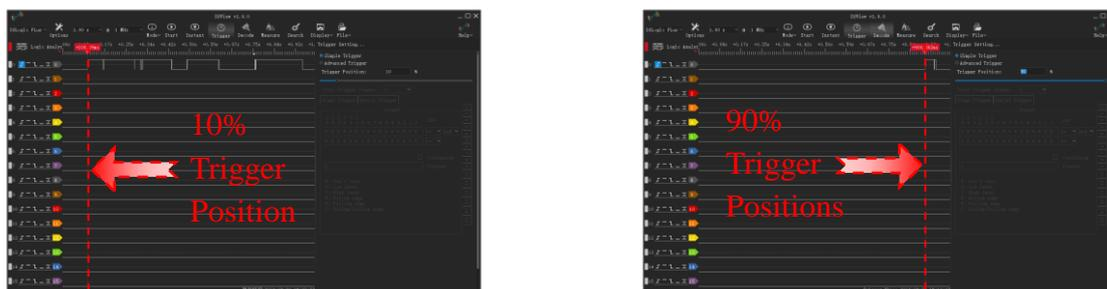

Figure 2-13

2.4.2 Simple Trigger

Simple Trigger allows for quick configuration of single/multiple channel edge or level triggers. It also supports trigger position setting. As Figure 2-12 shows, when **Simple Trigger** is selected in the trigger dock, the settings within the simple trigger area become the final trigger conditions.

Figure 2-14 shows the simple trigger setting for each channel.

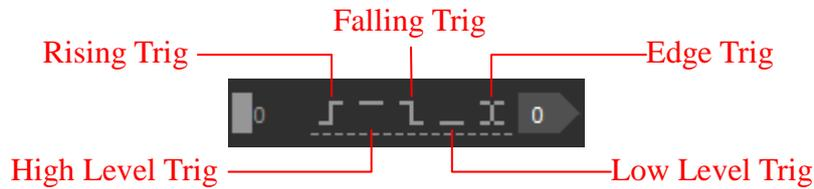

Figure 2-14

There are five icons from left to right: Rising, High Level, Falling, Low Level, and Either Edge.

Note: If multiple channels have been set with simple trigger conditions, they are combined with a logical "AND" relationship. This means that the Trigger will be activated only when all the conditions are met at the same sampling point.

2.4.3 Advanced Trigger



The Advanced Trigger mode is only available for configuration in the Buffer Mode. To use the Advanced Trigger mode, you need to set the Operation Mode to Buffer Mode.

Advanced Trigger is used to set complex triggering conditions, such as multi-event triggers and protocol triggers. DSView provides two types of advanced trigger settings: Stage Trigger and Serial Trigger.

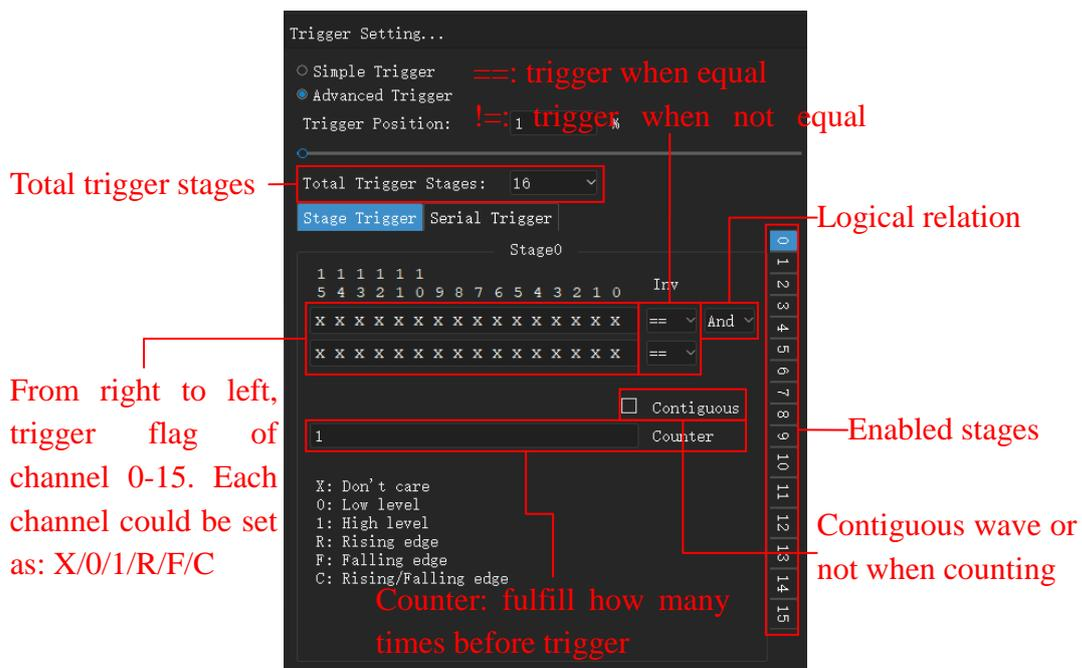

Figure 2-15

Stage Trigger supports up to 16 levels of trigger conditions, which means you can set up to 16 events to occur sequentially before triggering. Each level of trigger includes two sets of trigger conditions with logical operations (AND or OR). Each set of trigger conditions includes level and edge settings for all channels,

invert and counter setting.

Followings are some example of Stage Trigger

- High level of channel 0 keep longer than 1000 sample intervals

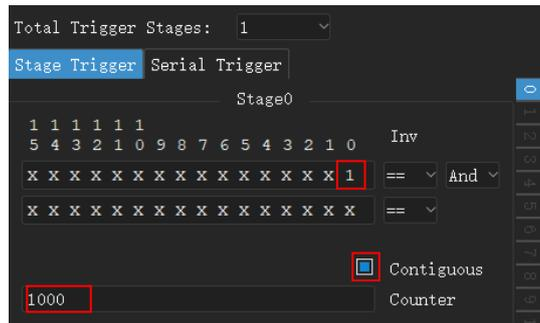

Figure 2-16

- Rising edge of channel 0 or falling edge of channel 1

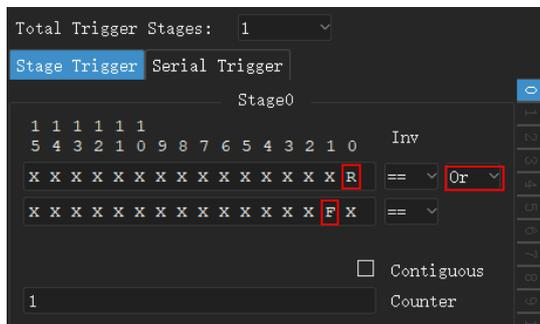

Figure 2-17

- Rising edge of channel 0, then 100 count of falling edge of channel 1, then high level of channel 2

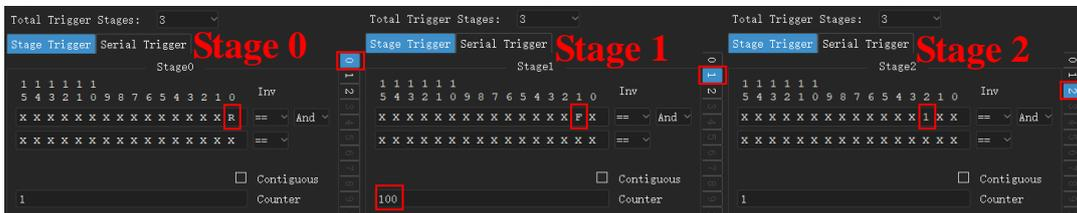

Figure 2-18

As Figure 2-19 show, Serial trigger designed a generic trigger template for serial bus, which can be used to setup complex protocol trigger. For example, trigger when there is 0x50 byte in the i2c data stream.

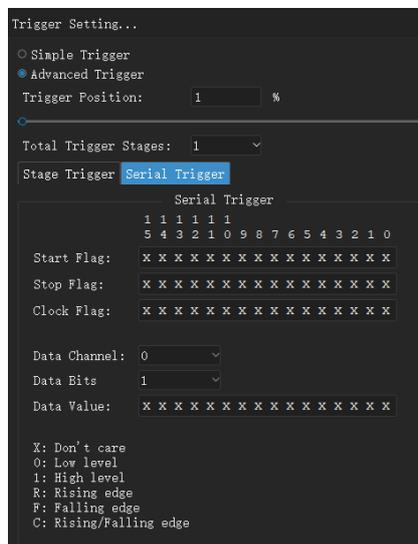

Figure 2-19

Behaviors of serial trigger: After *Start Flag* matched, value of *Data Channel* on each *Clock Flag* will be sampled and moved into a shift registers with bits of *Data Bits*. If the value of shift register is equal to the *Data Value* of most right *Data Bits*, trigger fired. Additionally, If *Stop Flag* matched, the shift register will be cleared.

Followings are some examples of serial trigger:

- Trigger when 0b010000100 appeared in I2C bus (channel 0: scl, channel 1: sda)

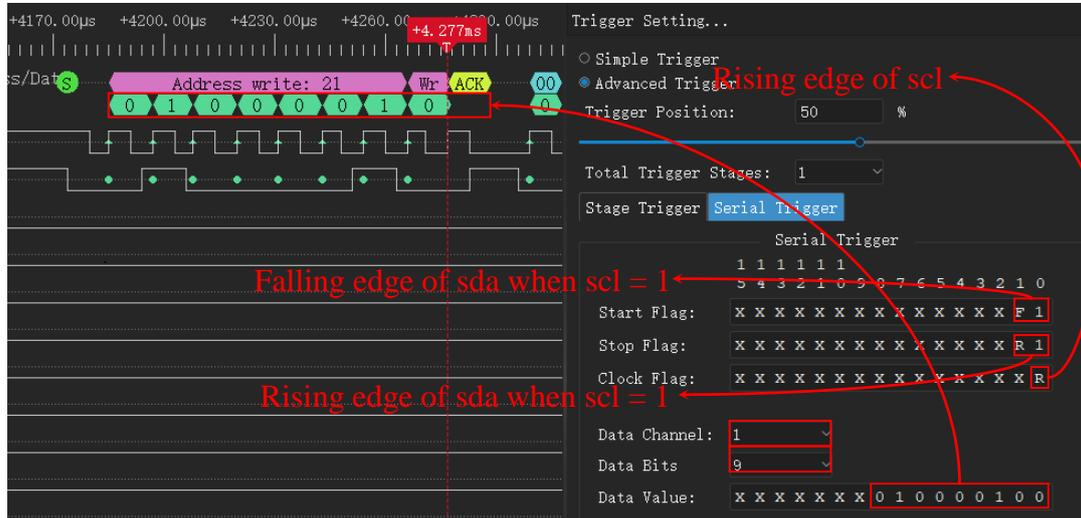

Figure 2-20

- Trigger when 0x1234 appeared in SPI bus (channel0: cs#, 1: clk, 2: miso, 3: mosi)

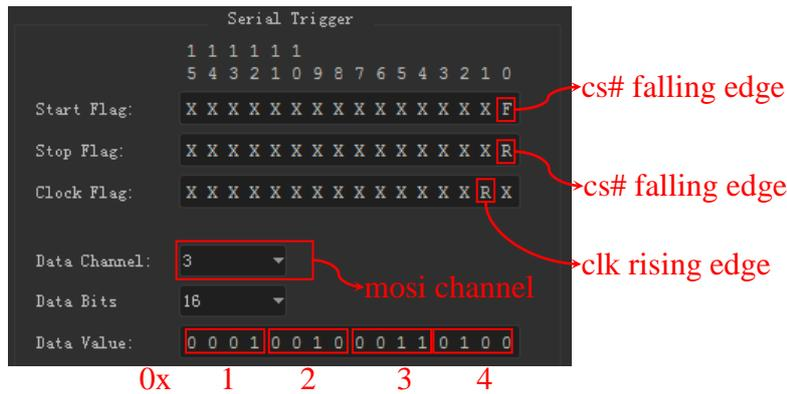

Figure 2-21

2.5 Capture

After configuring the relevant parameters for capture (device options, Sample Duration, sample rate, and trigger settings), you can start capturing data. As Figure 2-22 shows, DSView support two capture operations: Normal Capture and Instant Capture.

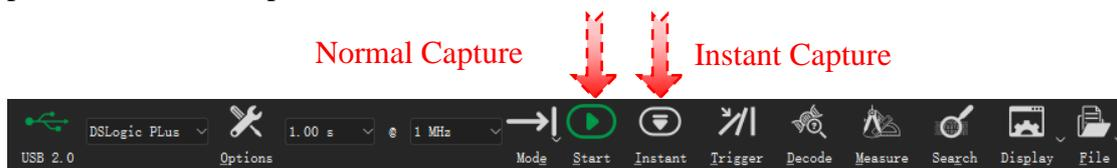

Figure 2-22

2.5.1 Normal Capture

DSLogic supports two different operating modes, the process of waveform capture also differs.

In Buffer Mode:

1. User initiates capture.
2. DSView sends sampling parameters to DSLogic.
3. DSView commands acquisition and waits for data.
4. DSLogic starts sampling immediately if no trigger set.
5. If trigger set, DSLogic waits for trigger.
6. **Once triggered, the logic analyzer returns the captured data when the acquisition duration reaches the set value or the buffer is filled.**
7. DSView receives the captured data
8. After data transfer is complete, DSView ends the current sampling and renders the waveform in the display window.

In Stream Mode, the first four steps are the same.

5. If trigger set, DSLogic waits for trigger. **(loop mode ignores all trigger conditions)**
6. **During the capture process, DSLogic continuously returns the captured data.**
7. DSView receives and displays the captured waveform in real-time.
8. In single/repeated capture, the capture stops when the set sampling duration is reached. In loop mode, the capture continues until the user presses the "Stop" button.

2.5.2 Instant Capture

The only difference between instant and normal capture is that instant capture ignores trigger settings. It captures the current waveform instantly for analysis without needing to modify trigger conditions.

As Figure 2-23 shows, if no input signal is present, the software waits at the 10% trigger position until the waveform satisfies the trigger condition.

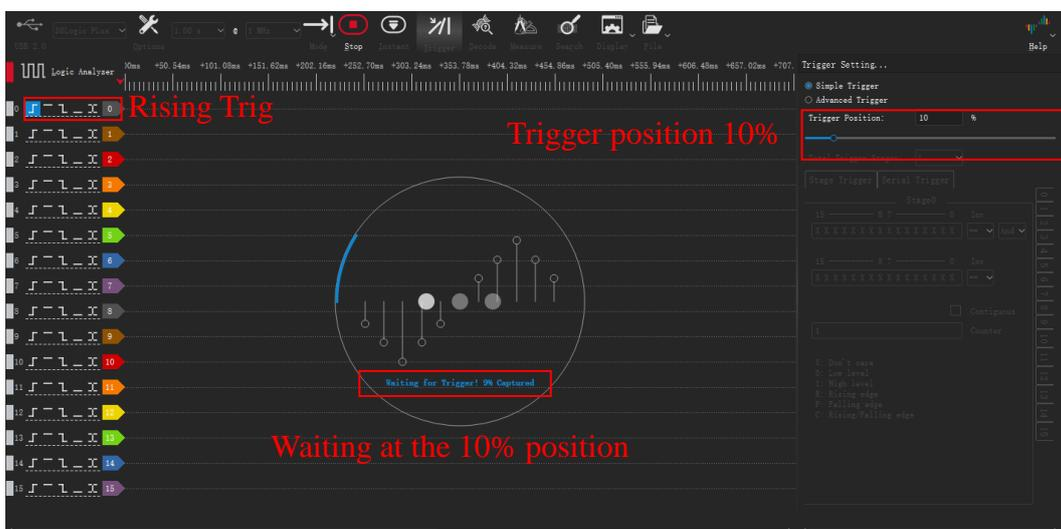

Figure 2-23

As Figure 2-24 shows, if we click **Instant**, DSView will ignore any trigger settings and capture the waveform immediately.

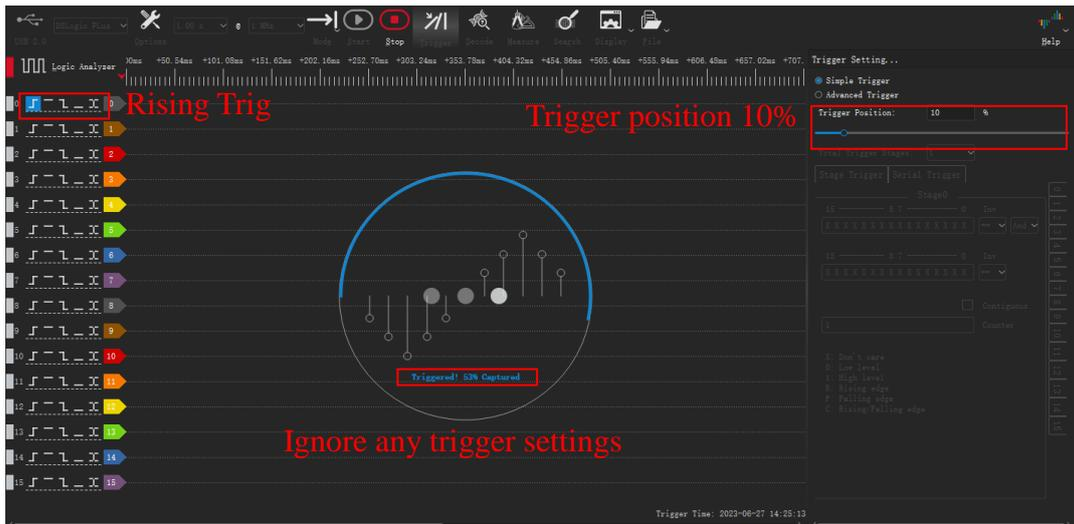

Figure 2-24

This mode is commonly used in the following scenario: when you have set a relatively complex trigger condition, but normal sampling fails to capture the waveform due to the trigger condition not being met. In such cases, you can use instant capture to view the current state of the signal, inspect the device under test, or modify the trigger conditions for the next normal capture.

2.5.3 Capture Mode

As Figure 2-25 shows, DSView supports different Capture Modes. In Buffer Mode, it supports Single and Repetitive Capture. In Stream Mode, it supports Single, Repeat and Loop Capture.

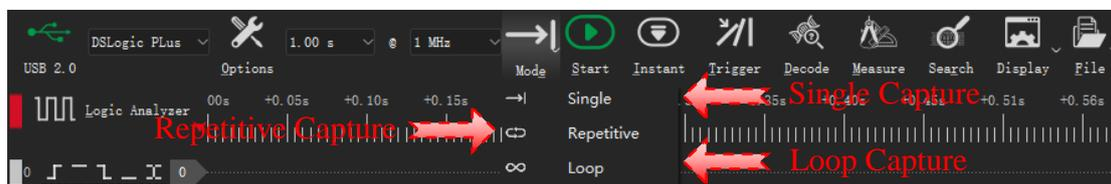

Figure 2-25

Buffer Mode:

Single Capture: As Figure 2-26 shows. In this mode, the capture operation is executed only once. When the specified Sample Duration is reached, DSView will stop the capture and upload the captured data for display in DSView.

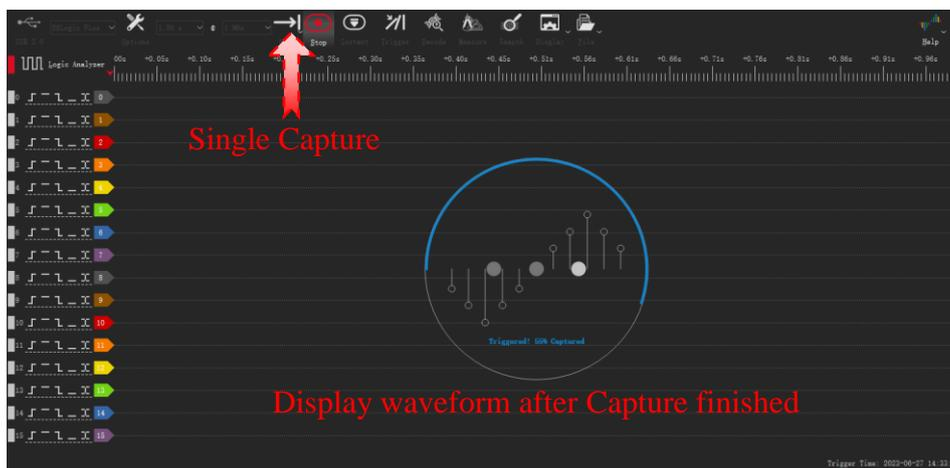

Figure 2-26

Repetitive Capture: As Figure 2-27 shows. In this mode, the capture operation is automatically repeated until the stop button is pressed. Combined with trigger condition settings, this mode allows us to continuously observe waveforms for specific events without any manual intervention. For example, each restart or each button press. In the Buffer Mode, Repetitive Capture supports defining the sampling interval time (from 0.1s to 10s) for each capture.

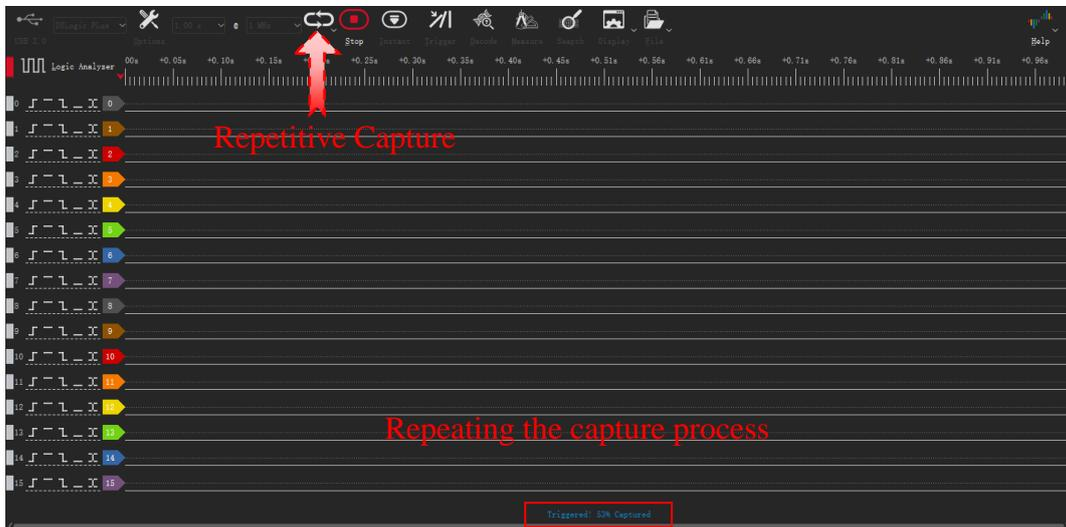

Figure 2-27

Stream Mode:

Single Capture: As Figure 2-28 shows, in this mode, the capture operation is executed only once. During the capture process, captured data is uploaded to DSView in real-time and displayed. When the displayed data length reaches the set Sample Duration, DSView will stop the capture.

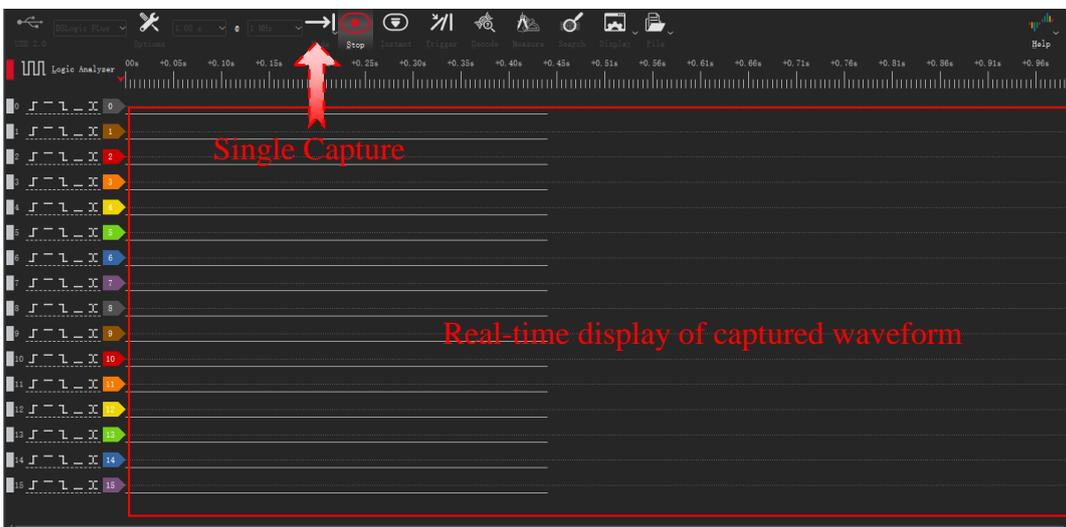

Figure 2-28

Repetitive capture: As Figure 2-29 shows, in this mode, the capture operation is automatically repeated until the stop button is pressed. During the capture process, the captured data is uploaded to DSView in real-time and displayed. When the displayed data length reaches the set Sample Duration, DSView will end the current capture and proceed to the next one.

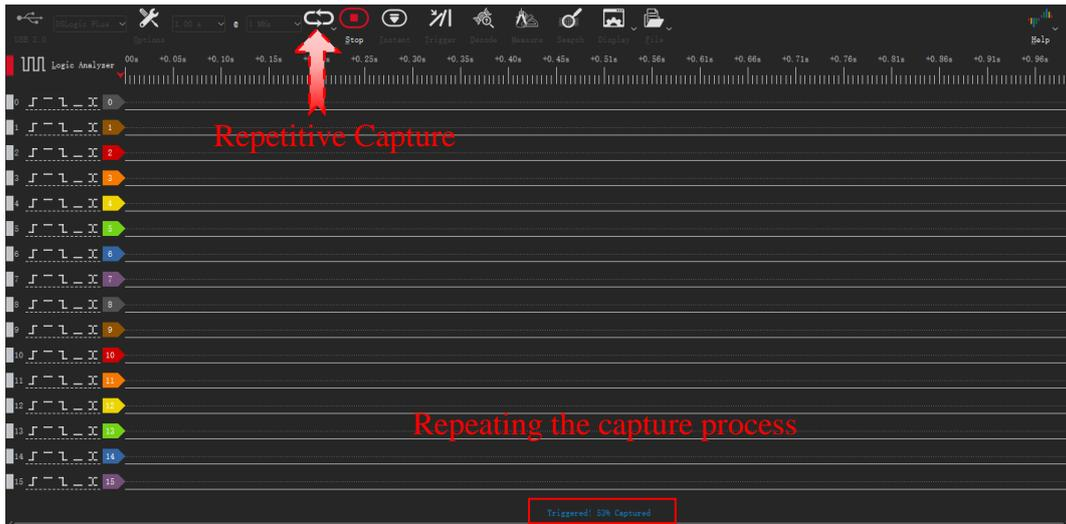

Figure 2-29

Loop mode: As Figure 2-30 shows, in this mode, the capture continues until the stop button is pressed. During the capture process, the waveform data is uploaded in real-time to DSView for display. When the displayed waveform length reaches the sample duration, loop mode does not stop the capture. Instead, it continuously shifts the old waveform data to the left and appends new waveform data to the right, creating a "scrolling" effect. This mode allows us to observe all the captured waveforms in real-time. When the target waveform appears, we can manually stop the acquisition for waveform analysis.

Note: In loop mode, all trigger condition settings are ignored.

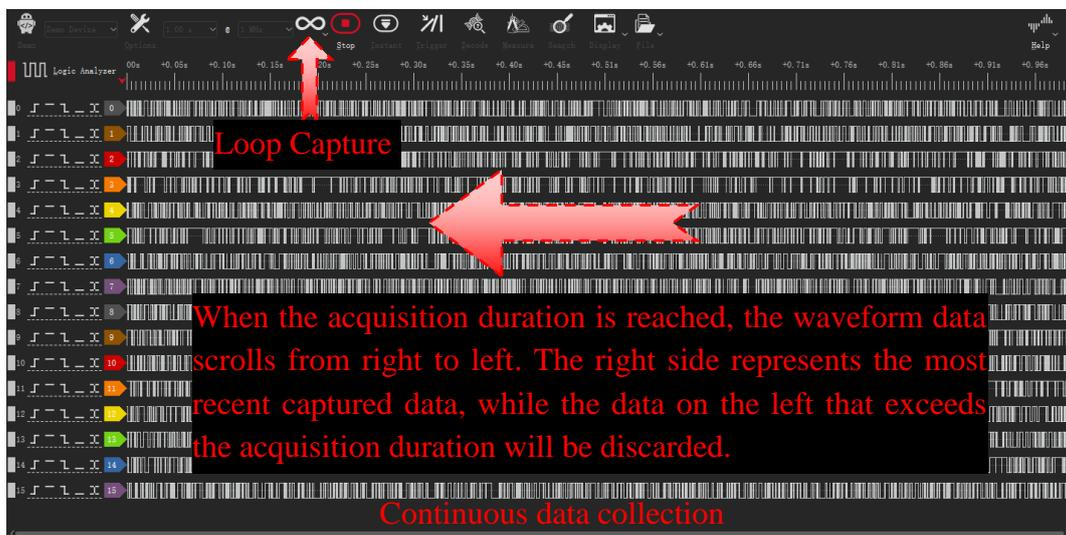

Figure 2-30

DSLogic supports 3 capture modes that effectively cover different requirements. The single capture mode is suitable when you only want to capture the current waveform or a waveform under specific trigger conditions. The repetitive capture mode is ideal for observing waveforms of the same event multiple times or capturing waveforms at each trigger of a repetitive event. The loop mode is useful when the capture target is not well-defined, and you want to dynamically observe and determine the waveform segment to capture in real-time.

2.6 Navigating

As Figure 2-31 shows, the captured data will be displayed graphically in the wave window.

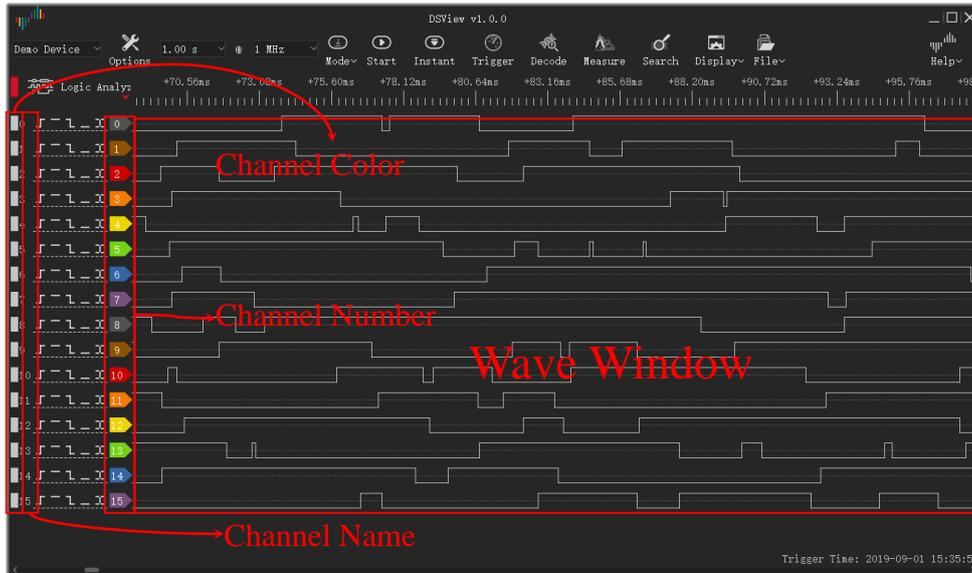

Figure 2-31

2.6.1 Pan Left/Right

Small range: Drag the waveform by holding the left mouse button and moving it.



Dynamic scrolling: Within the waveform window, hold down the left mouse button, quickly move the mouse to the left or right, and release to initiate dynamic scrolling, then gradually slows down until it stops. Click **Display > Options**, and in the Display Options dialog, enable/disable this feature.



Large range: Drag the scroll bar in window bottom will quickly jump to a certain position.

Shortcut key: press the shortcut key "Page Up" or "Page Down" to drag the wave to left/right.

2.6.2 Zoom in/Out

Wheel zoom: Within the waveform window, scroll the wheel of mouse will zoom the wave in/out.

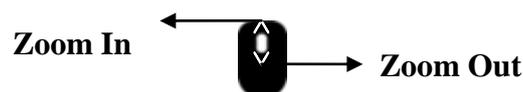

Window zoom: In the wave window, press the right button of mouse, move mouse to draw a rectangle window, selected area will be zoom to full window when release the right button.

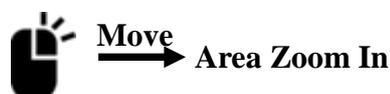

Zoom toggle: In the wave window, if it's not the max zoom out state, double click the right button of mouse will reach the max zoom out state, double click again will return back to the previous zoom set.

2.6.3 Pattern Search

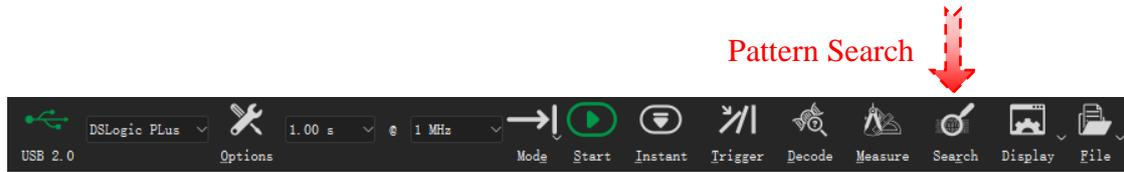

Figure 2-32

As Figure 2-32 shows, clicking Search button or press the shortcut key "R" will bring up the search box at the bottom of the window, as Figure 2-33 shows:

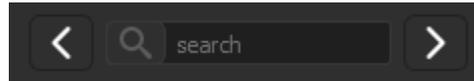

Figure 2-33

Clicking on the search box will open the search settings window. For example, as Figure 2-34 shows, you can set the search to find any rising/falling edge on Channel 0. Click **OK** will finalize the search settings. Afterwards, you can use the **Pre** and **Next** buttons in the search box to find the edges on Channel 0 within the wave window.

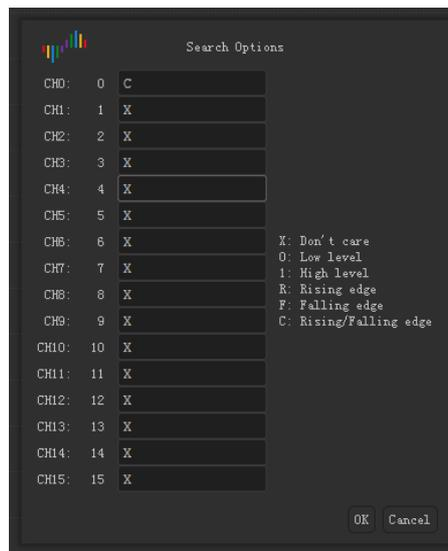

Figure 2-34

2.6.4 Channel Customization

- Channel color/name:**

As Figure 2-35 shows, click color/name area to modify the color/name of specific channel.



Figure 2-35

- Channel move:**

As Figure 2-36 shows, when hover the mouse over the Channel Label, an arrow symbol will appear. There are three methods to move the channel in this case:

Method 1: Hold down the left button of mouse and drag the mouse. The channel will move along with

the mouse. Release the left button of mouse when the channel reaches the desired position.

Method 2: Click the left button of mouse to select the channel you want to move. Then, move the mouse, and the channel will follow the mouse movement. Click the left button of mouse again to release the channel when it reaches the desired position.

Method 3: Hold down the shortcut key "Ctrl" key and select multiple channels that you want to move. Then, move the mouse, and the selected channels will follow the mouse movement. Click the left button of mouse again to release the channels when they reach the desired position.



Figure 2-36

2.7 Measurement

DSView provides a wide range of measurement options, primarily achieved through mouse positioning and cursor insertion. Simply by moving the mouse to the desired waveform area, you can measure parameters such as pulse width, frequency, period, duty cycle, and edge count for the corresponding waveform. Additionally, DSView supports the insertion of multiple cursors, allowing for waveform measurement, positioning, and navigation as needed.

2.7.1 Width/Period/Frequency/Duty Cycle

As Figure 2-37 shows, when the captured data is displayed in the wave window, you can hover the mouse over any pulse position in a channel to view the width, frequency, period, and duty cycle of the current pulse.

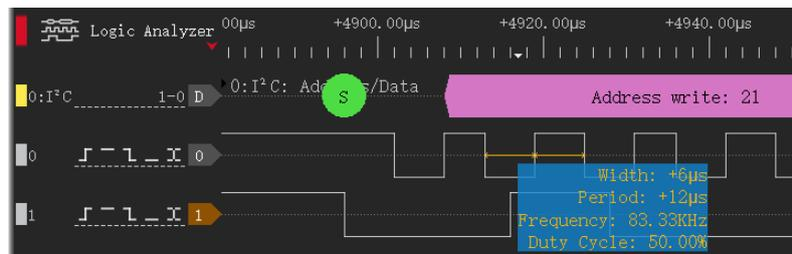

Figure 2-37

2.7.2 Pulse Counter

As Figure 2-38 shows, you can also use mouse operations to count the number of edges in any channel within a specified time period. The specific steps are as follows:

1. Move the mouse to the waveform area of the channel to be measured (between the high and low levels of the channel).
2. Move the mouse to the desired starting position.
3. Click the left button of mouse and then move the mouse to the desired ending position. This process will dynamically display the number of edges, rising edges, and falling edges in the current channel within the measurement range.
4. Click the left button of mouse again to complete the measurement.

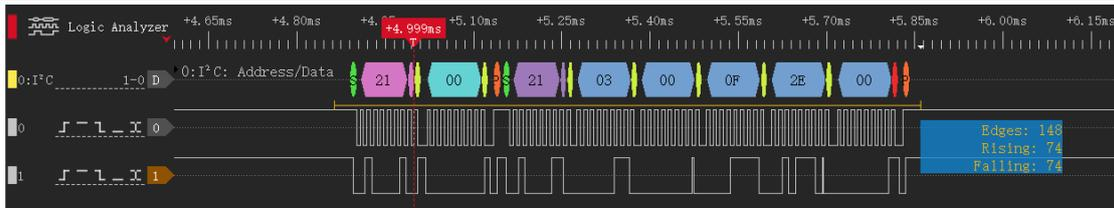

Figure 2-38

2.7.3 Edge distance

As Figure 2-39 shows, you can measure the distance between any two edges using mouse operations.

The specific steps are as follows:

1. Move the mouse to the position of certain edge, and click the left button to select the start edge.
2. Move the mouse to the position of the end edge, and the distance between the two edges will be displayed (duration/sample interval).
3. Click the left button of mouse to complete the measurement.



Figure 2-39

2.7.4 Cursor Insert

Method 1: In the wave window, move the mouse to the desired position where you want to insert a cursor, and double-click the left button of mouse to insert a new cursor.



Figure 2-40

Method 2: In time ruler area, move the mouse to the desired position where you want to insert a cursor, click the left button of mouse, and an arrow-down region will appear. Within this region, click the left button of mouse again to insert a new cursor.

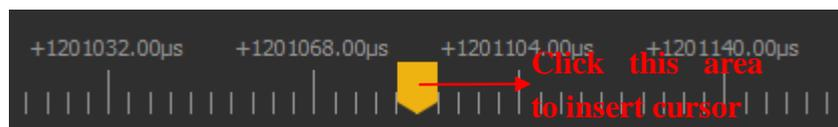

Figure 2-41

2.7.5 Cursor Move

Method 1: Move the mouse to the cursor position. When the cursor is highlighted in bold, click the left button of mouse to select the cursor you want to move. The cursor will then follow the mouse movement. If you want the cursor to snap to a specific edge of a waveform in a particular channel, simply move the mouse close to that edge. Within a certain range, the cursor will automatically snap to the position of that edge.

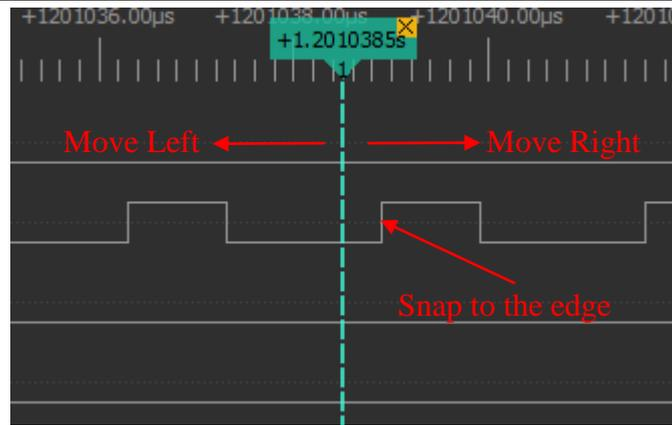

Figure 2-42

Method 2: In time ruler area, move the mouse to any position and click the left button of mouse. This will display the numbers of all existing cursors. Click on any number to move the corresponding cursor to the position indicated by the arrow.



Figure 2-43

2.7.6 Cursor Jump

Cursors can help us mark important positions for easy reference. The following operation allows you to navigate between cursor positions. On the time ruler, click the right button of mouse at any position. This will display the numbers of all existing cursors. Click on any number to navigate to the position of that cursor.



Figure 2-44

2.7.7 Cursor Measure

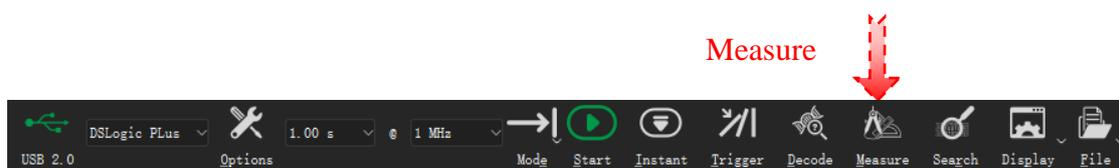

Figure 2-45

As Figure 2-45 shows, Click **Measure** button or press the shortcut key "M", measure dock will be opened. There are two measure groups: Distance Measure and Edges Counter.

Distance measure: This can be used to measure the time or sample count between two cursors. Click **+** button to add a new set of distance measurement, and then click the start/end area to select the start/end cursor individually.

Edges counter: This can be used to count edges between two cursors on specific channel. Click **+** button to add a new set of edges counter, and then select start/end cursor and channel number to be measured.

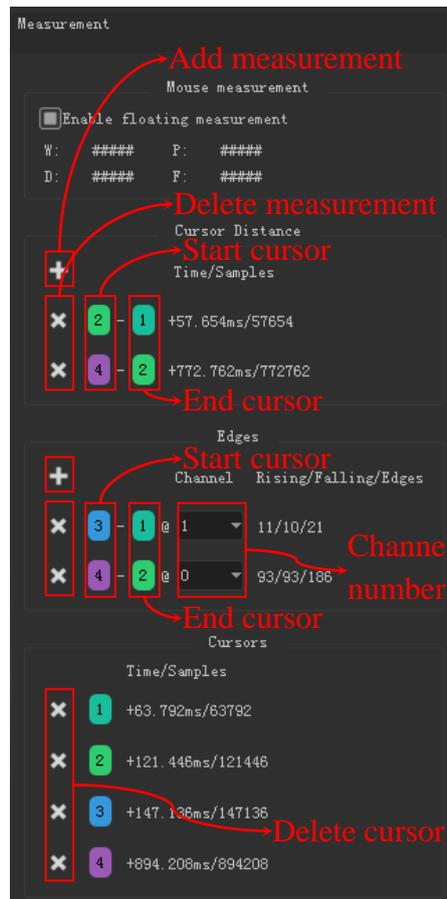

Figure 2-46

2.7.8 Delete Cursor

As Figure 2-47 shows, click the 'x' area of any cursor will delete the cursor, and remain cursors will be renumbered.

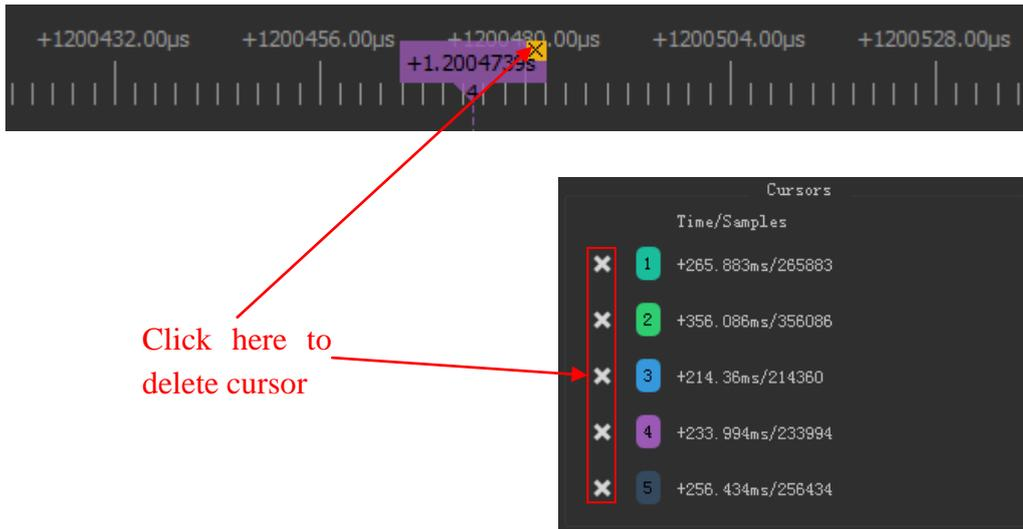

Figure 2-47

2.8 Protocol Decoder



Figure 2-48

Protocol decoder is one of the important features of a logic analyzer. After capturing data, it is necessary to interpret the data into specific protocol instructions in order to understand the practical meaning of the data. Protocol decode helps us accomplish this task effectively.

Click **Decoder** button or press the shortcut key "D", decoder dock will be opened. As Figure 2-49 shows, decoder dock consists of two parts: Decoder Select, and Protocol List Viewer.

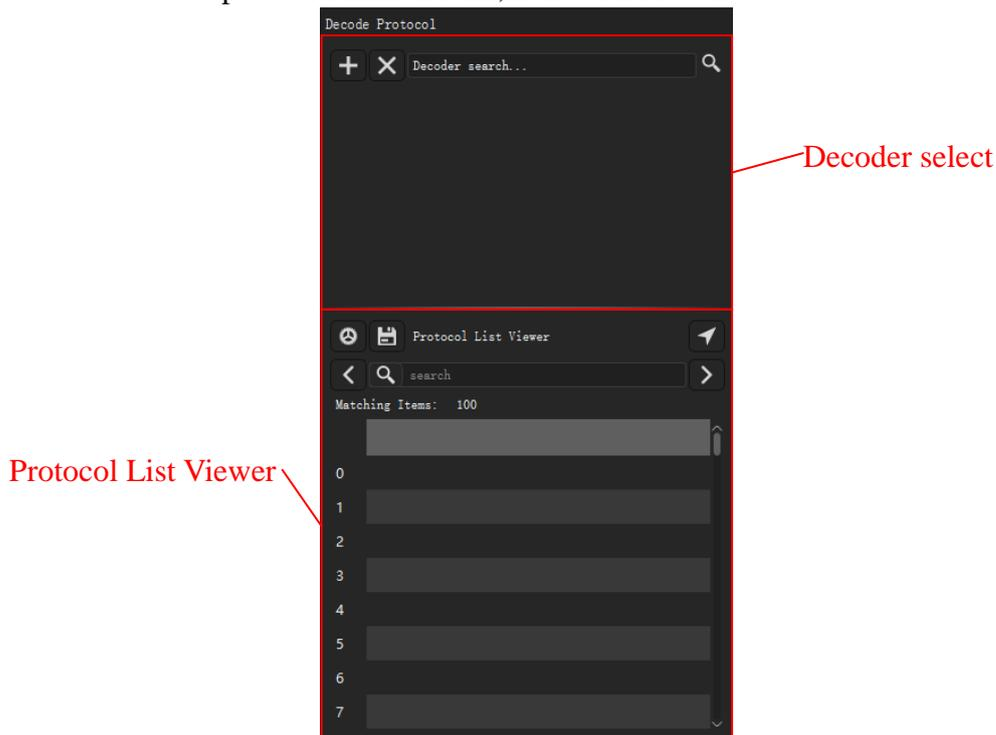

Figure 2-49

2.8.1 Add Decoder



The decoder with a 0-prefix is a simplified version that does not include bits information and does not support high-level protocols with stack. The advantage of this version is faster decoding speed and lower memory consumption.

Click on the protocol search box will bring up a protocol list. You can scroll through the list using the scroll wheel or enter a keyword to find the desired protocol to add. For example, if we need to add the I2C protocol, we simply need to click on the I2C protocol in the protocol list.

Here, we directly use the I2C protocol from the protocol list, which will open the settings window for that protocol, including content display, protocol channel, protocol parameters, and decoding region settings, as shown in Figure 2-50, click the OK button to successfully add the new protocol. If multiple protocols need to be added, simply select and add them one by one from the protocol list.

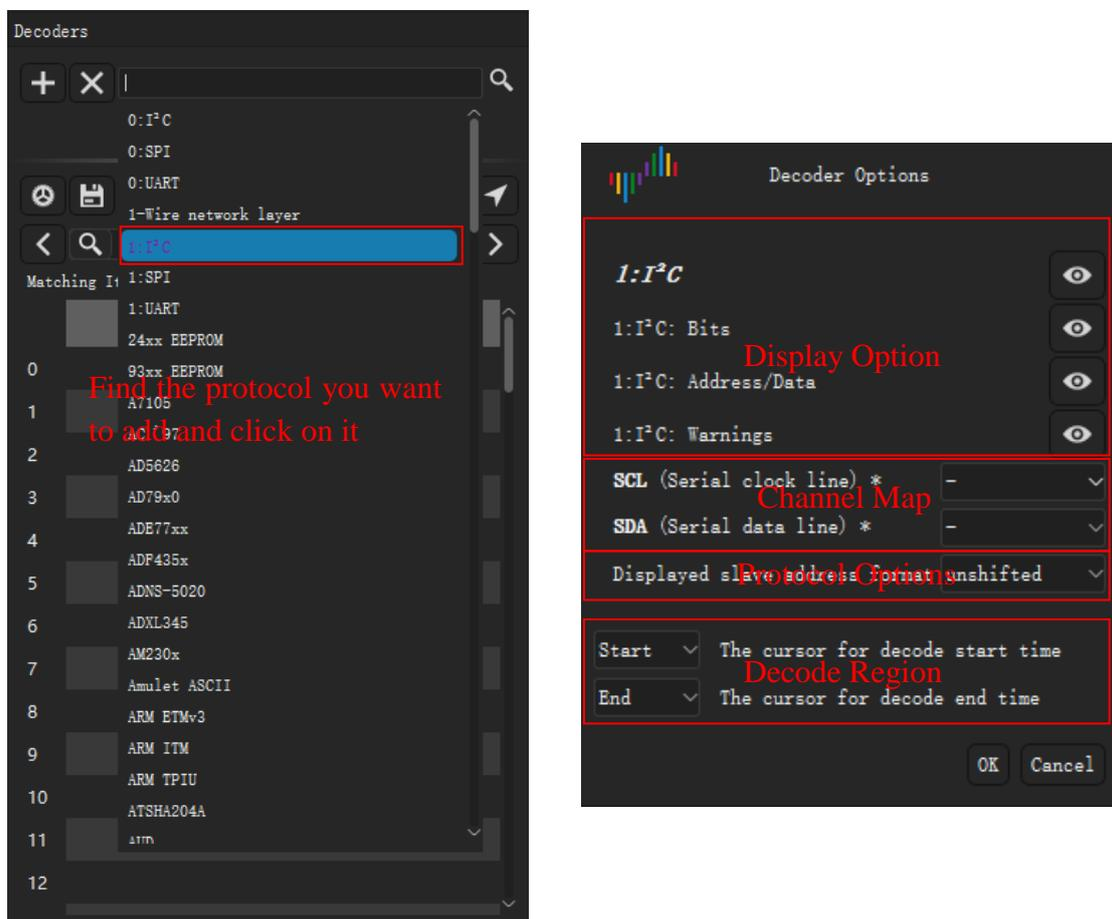

Figure 2-50

As Figure 2-51 shows, clicking on the "Gear" button allows you to reopen the settings window for a protocol. Clicking on the "+" button allows you to add the recently added decoder.

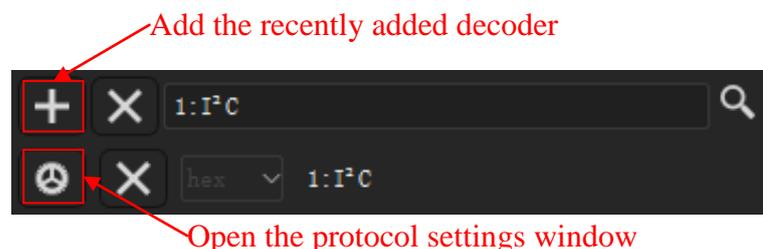

Figure 2-51

By default, after adding a protocol, the entire waveform will be decoded. However, there may be

situations where we only want to decode a portion of the waveform to shorten the decoding time. For example, in a captured waveform, there may be noise or irregular waveforms during the reset process. In such cases, the start and end positions for decoding can be set using the region decoding settings. The start and end positions can be set using the cursor, so you simply need to insert the cursor at the desired moment to set it as the start or end position.

As Figure 2-52 shows, setting cursor 2 as the decoding end position means that the waveform after cursor 2 will not be decoded.

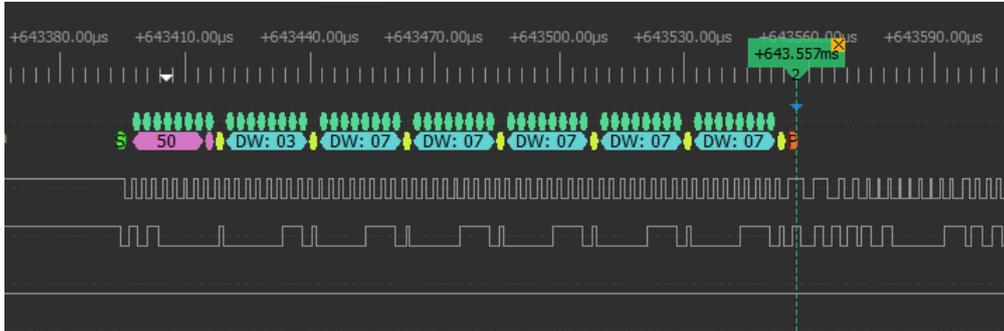

Figure 2-52

2.8.2 Stack Decoder

Most complex protocols are designed in layers, such as the typical TCP/IP 7-layer protocol. Adding multiple-layer protocols in DSView follows the same process as simple protocols. You can search the protocol list to find the top-level protocol you want to add. DSView will automatically analyze the required lower-level protocols and generate the corresponding settings window. Users only need to set the parameters in the popped-up protocol settings window to successfully add the new multiple-layer protocol.

As Figure 2-53 shows, when we need to add 24xx EEPROM protocol, we simply find the 24xx EEPROM protocol in the protocol list and set parameters for all layers in the protocol settings window.

Due to the numerous types of protocols, to quickly find the desired protocol, you can directly filter by entering keywords in the search box. For example, by entering "24" here, the list will only display protocols with names that include "24". This makes it more convenient to find/add the desired protocol decoders.

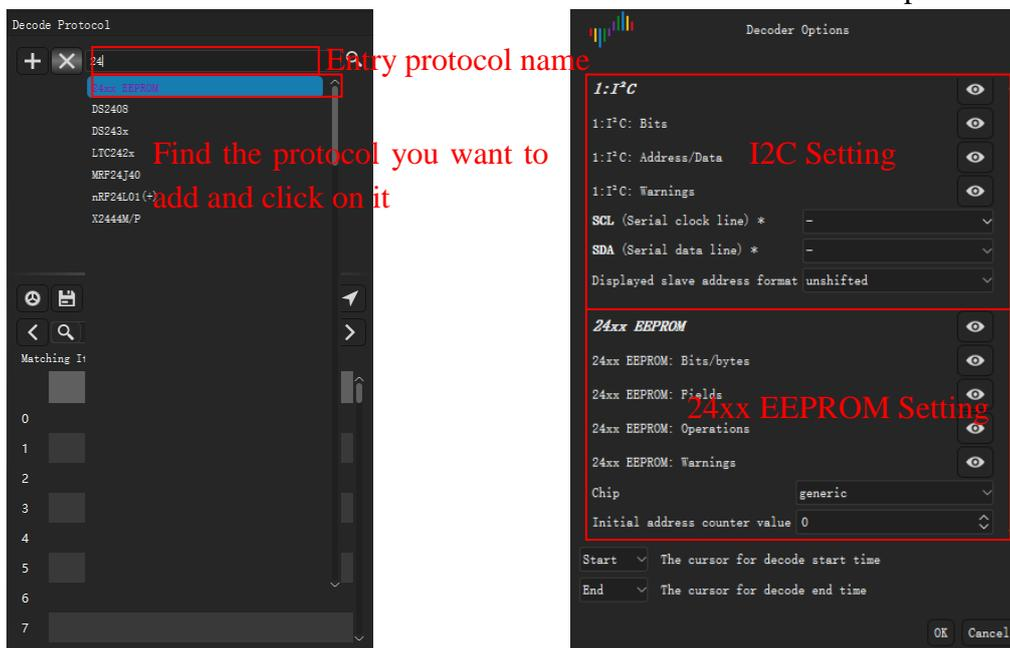

Figure 2-53

The decoding result for the 24xx EEPROM protocol shown in Figure 2-54 is not limited to I2C read/write operations, but also includes higher-level commands and data for the EEPROM.

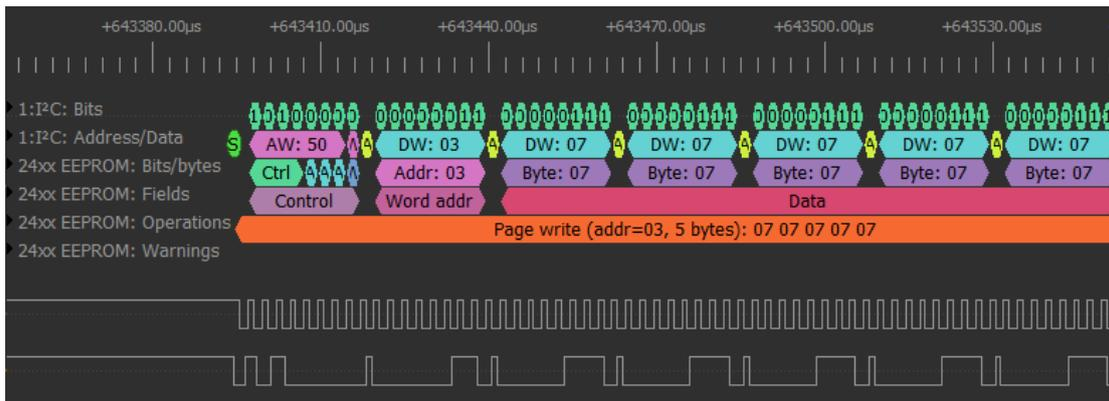

Figure 2-54

2.8.3 List Viewer

The graphical display of decoder results helps us understand waveforms intuitively. However, when there are too many decoder results, it becomes difficult to view them conveniently on the screen and search for specific decoder results. The List Viewer effectively solves this problem.

As Figure 2-55 shows, click on any row of the list viewer can map to the same location in the wave window.

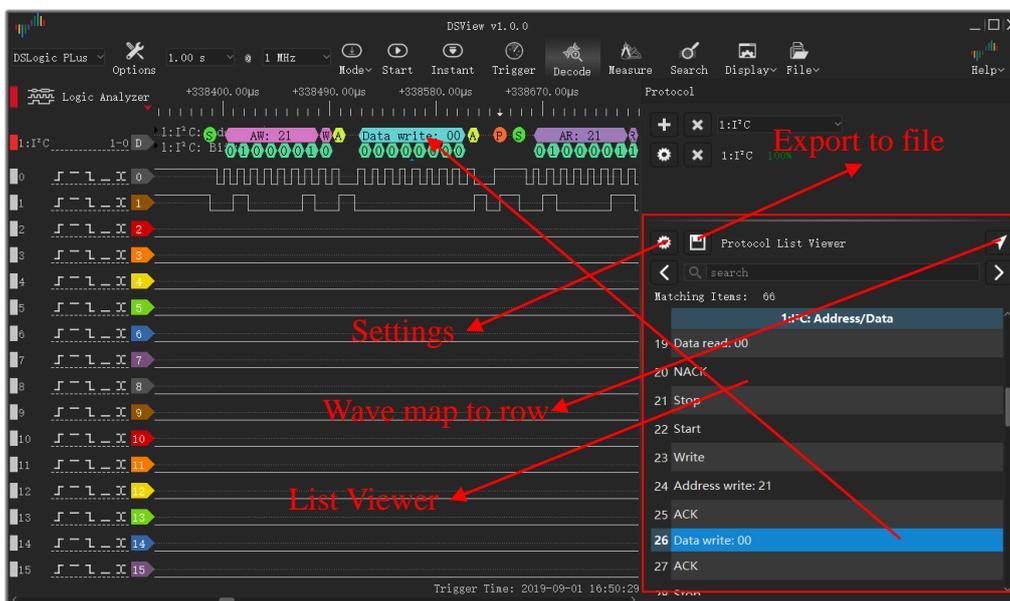

Figure 2-55

2.8.4 Search Results

The List Viewer allows decoder results to be treated as strings for result searching. DSView supports simple single-line content search and multi-bytes data search.

As Figure 2-56 shows, you can enter the keyword you want to search in the search text editor, and then click the previous/next button to find the decoding content that includes the keyword. The wave windows will also jump to the corresponding position for analysis.

If you are analyzing a specific segment of decoder results, you can click on a row to select it, and the previous/next button will search for the previous and next matching items starting from that row, instead of searching from the beginning.

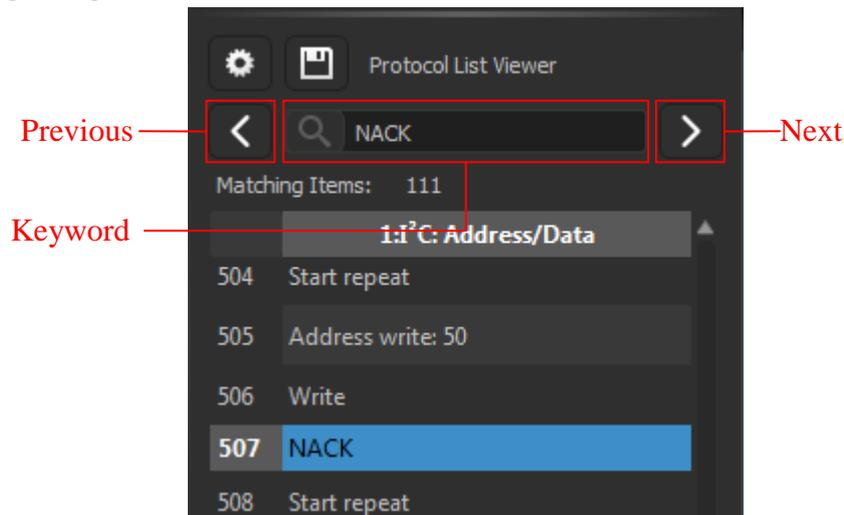

Figure 2-56

If want to search multi-bytes data in the decoder results. Symbol ‘-’ should be used. For example, “70-70-70” indicates three consecutive data. As Figure 2-57 shows, click pre/next button will find out all “70-70-70” data.

Note: Currently, DSView only support multi-bytes data search for UART/I2C/SPI decoders.

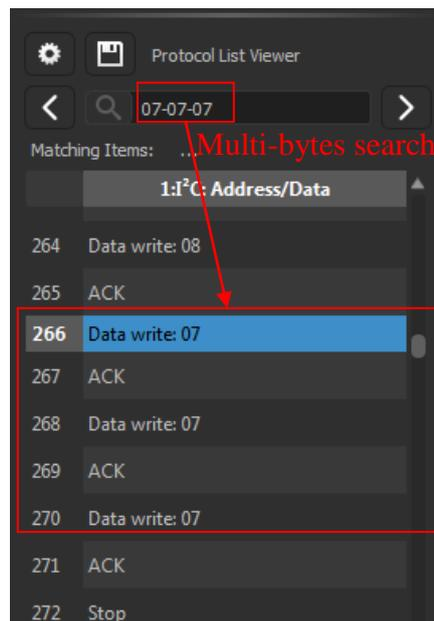

Figure 2-57

2.8.5 Export Results

DSView supports exporting the protocol decoding results to a file for further processing. As Figure 2-58 shows, you can click the save button in the list viewer window to save the results as a text file in CSV or TXT format.

Moreover, DSView supports exporting multiple columns of decoding results to the same file. You just need to select all the desired columns to export during the exporting process. The final result will be automatically arranged in time order.

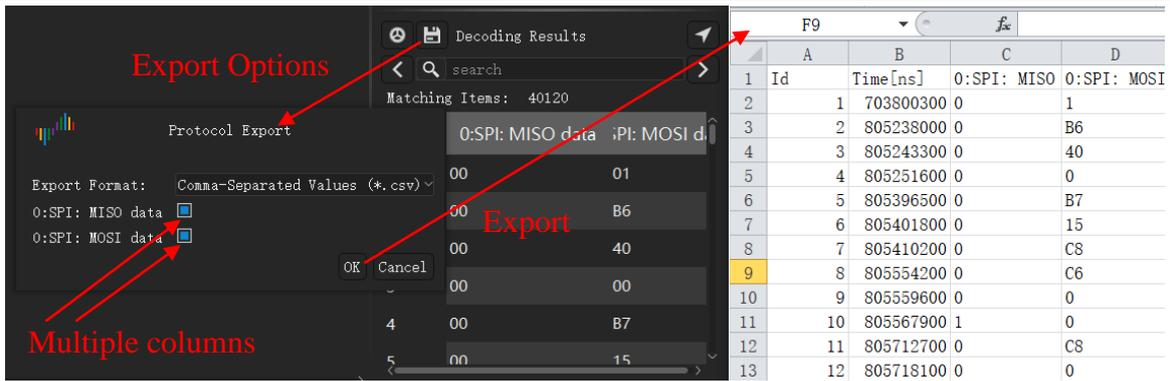

Figure 2-58

2.8.6 Delete Decoder

You can delete added protocol decoders. Clicking the "X" button in the protocol add panel will delete all currently added decoders, while clicking the "X" button before a specific protocol will delete that particular decoder.

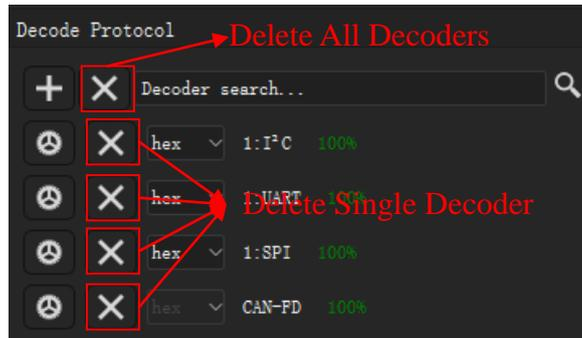

Figure 2-59

2.9 File Operation

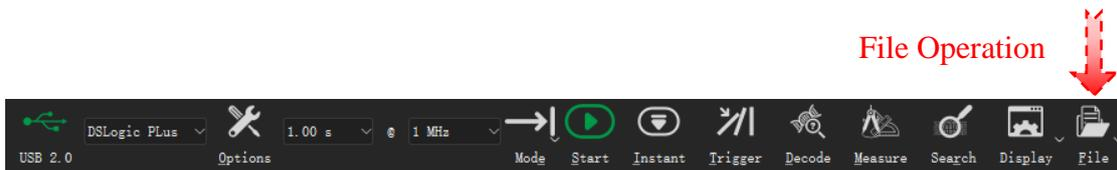

Figure 2-60

Click **File** button will bring up the menu for file-related operations, as Figure 2-60 shows. DSView supports session load/save, data save/open, data export, screenshot, and more.

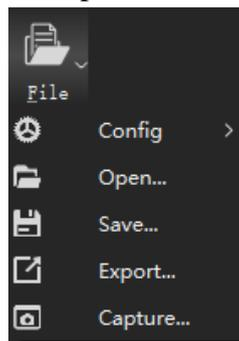

Figure 2-61

2.9.1 Load/Save Session

Session represents the current settings, including device options, channel enable/disable, colors, names, and trigger settings. Select **Config > Save Session** to save the current settings to a file. To import a specific configuration, select **Config > Load Session** and choose the corresponding configuration file.

By selecting **Config > Load Default Session**, you can load the default settings, which restore the device to its factory default condition. DSView also supports automatic saving and loading of configurations. When you reopen the software, it will automatically load the settings from the previous session before it was closed.

2.9.2 Save

Click **File > Save** and set the desired file path to save the current data in a file format that can be parsed by DSView for later opening and viewing.

2.9.3 Open

Click **File > Open** and select the data file you want to load. The data will be reloaded and displayed in the wave window. DSView only supports opening files with the .dsl file extension.

2.9.4 Export

DSView allows you to export current data to different file formats for other use. In the logic analyzer mode, you can click "**File**" > "**Export**" to choose from formats such as CSV, VCD, and Gnuplot

As Figure 2-62 shows, when exporting a CSV file, you can choose to export either raw or compressed data.

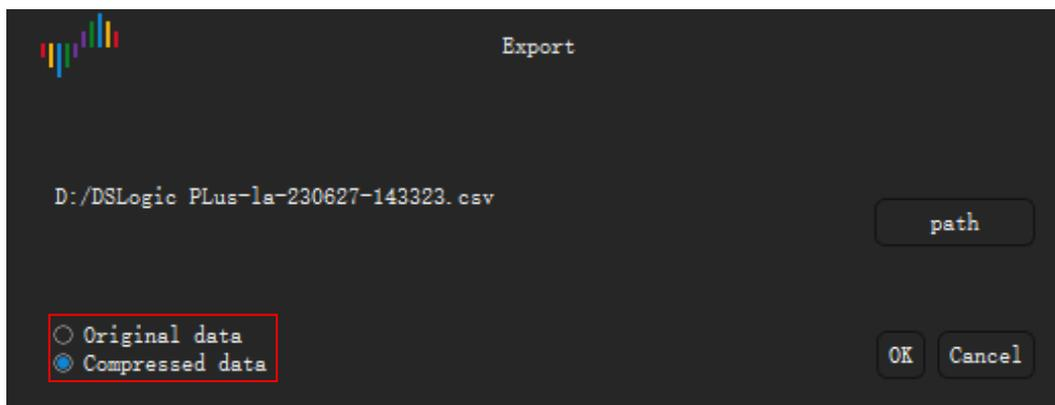

Figure 2-62

2.9.5 Screen Shot

If you want to save the current screen as an image, you can choose the screenshot operation. Click **File > Capture**, and it will save the current screen as a PNG file.

3 Oscilloscope

3.1 Hardware Connection

- 1) Connect the DSCOpe to the USB port of the PC using a USB data cable. If the DSView software is not running, the hardware indicator light should be **red**.



Please use the original or a high-quality and short USB data cable, and connect it directly to the USB port on the motherboard. Try to avoid using hub extension ports or front panel ports on the computer case to ensure the best USB connection quality.

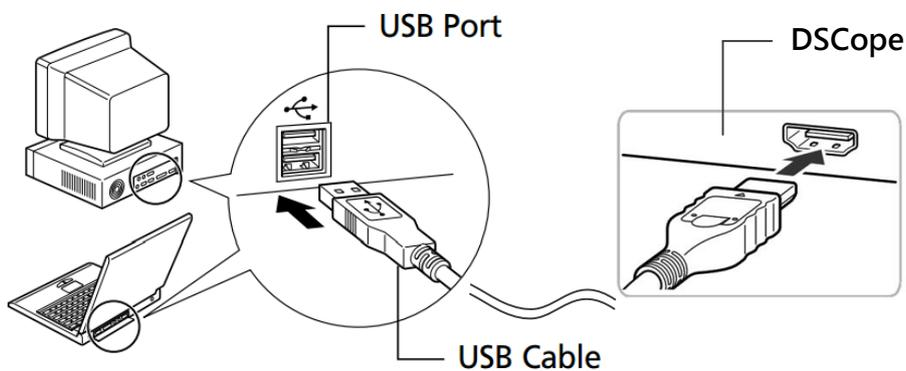

Figure 3-1

- 2) Open the DSView software (the system may need to search for drivers for the first time on Windows, please wait patiently). Confirm that the hardware indicator light turns **green**, indicating that the DSView software has successfully recognized the device and displays the correct device name in the device combobox.

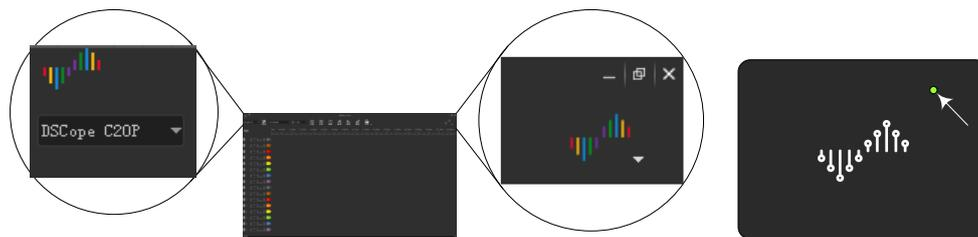

Figure 3-2

- 3) Connect probes to the input of DSCOpe.

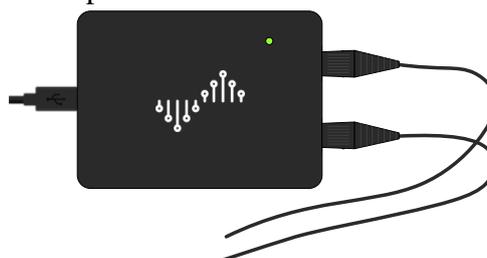

Figure 3-3

- 4) To take measurements, connect the probe's ground and signal end to the target test board's ground and measured signal end. Set the scaling ratio of the probe to a reasonable position.



The probe, oscilloscope, and PC grounds are connected, so ensure that both sides have the same potential to avoid damaging the equipment.

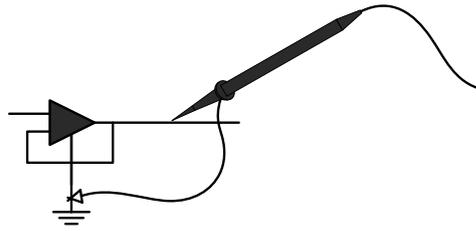

Figure 3-4

3.2 Hardware Options

Click **Options** button (Figure 3-5) or press the shortcut key "O":

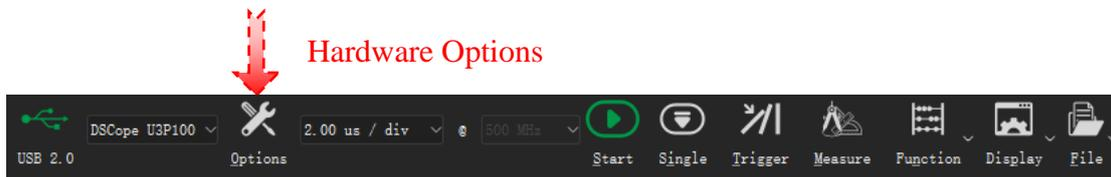

Figure 3-5

Device options window will be opened (Figure 3-6).

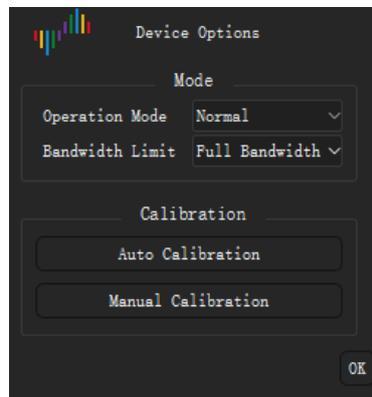

Figure 3-6

3.2.1 Operation Mode/Bandwidth Limit

- **Operation Mode:**
 - **Normal:** Normal working
 - **Internal Test:** Test only.
- **Bandwidth Limit:**
 - **Full Bandwidth:** No limit.
 - **20Mhz:** Limit to 20MHz

3.2.2 Auto Calibration

In order to ensure high precision in varying temperature and humidity conditions, oscilloscope require parameter calibration. DSView offers two calibration methods: Auto Calibration and Manual Calibration.

Click **Auto Calibration** button in Device option windows, a message window (Figure 3-7) will be shown.

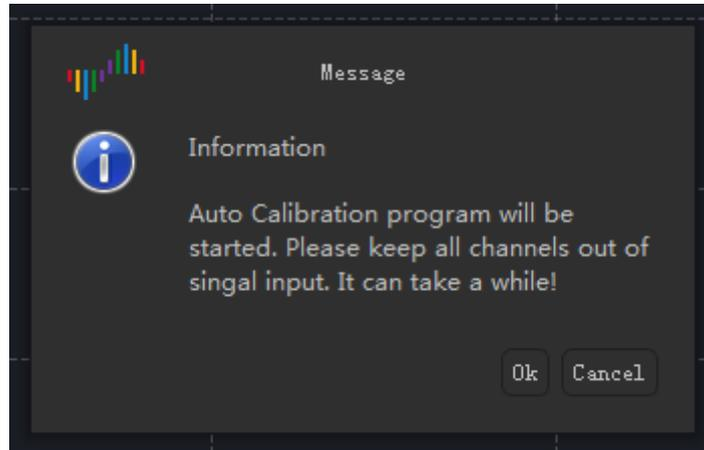

Figure 3-7

Please ensure that the device input terminal is floating, without any probe connected. Click the **OK** button to start the Auto Calibration process. Normally, the calibration process will take a few minutes to complete. Once finished, a message will appear as Figure 3-8 shows, indicating the end of calibration. You can click the **Save** button to complete the calibration and save the calibration results. During the calibration, you can also click the **Abort** button to stop the process, and the hardware will automatically revert to the state before calibration.

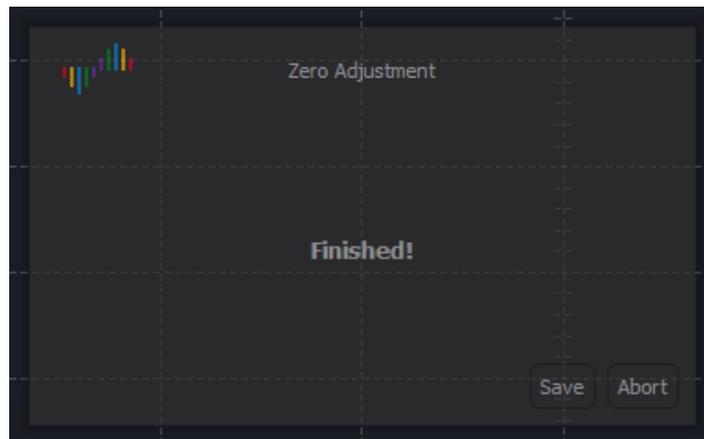

Figure 3-8

3.2.3 Manual Calibration

Click **Manual Calibration** button will bring up the Manual Calibration window, as Figure 3-9 shows. From top to bottom, there are options for adjusting the gain and offset of Channel 0, followed by options for adjusting the gain and offset of Channel 1.

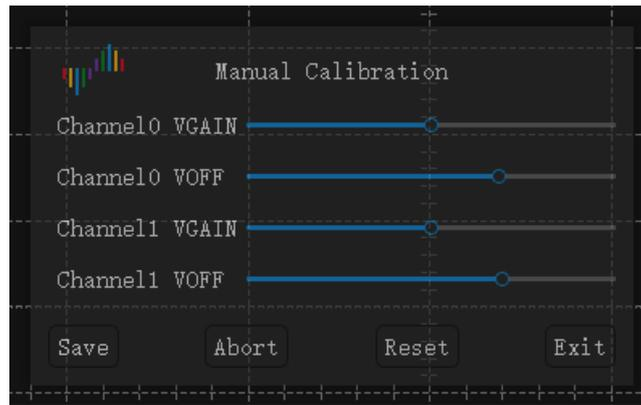

Figure 3-9

Manual Calibration requires adjustments to be made for each Vertical Scale individually. To observe real-time adjustment results, the software needs to be in running status, and the waveform should be monitored to confirm the adjustments. The specific steps for calibration are as follows:

1. Click the **Manual Calibration** button to open the Manual Calibration window.
2. Click the **Start** button to set the software to running mode. If adjusting the offset, ground the probe and observe the zero position to confirm the adjustment results. If adjusting the gain, provide a calibration source signal to confirm the adjustment results.
3. Adjust the Vertical Scale to the target position.
4. Drag the slider in the Manual Calibration window while monitoring the waveform to ensure it meets the requirements.
5. If adjustments need to be made for other Vertical Scales, go back to step 3.
6. Once the calibration is completed, click the **Save** button to save the current calibration results.

If you don't want to save the current calibration results, you can click the **Abort** button. DSView will reload the previous settings. If you only want to temporarily use the current calibration results, you can simply click the **Exit** button. The adjusted parameters will be used by the hardware until it is powered off. Once the device is powered on again, it will load the previous settings.

Since the Auto Calibration is based on the previously saved parameters, if you accidentally save incorrect manual calibration results, you can click the **Reset** button to restore the original default state. After resetting, you will need to perform the Auto Calibration again.

3.3 Capture

3.3.1 Channel Customization

The settings for each channel are shown in Figure 3-10.

Enable: Turn on/off the channel.

Vertical Scale: Set the vertical range, which represents the actual voltage value for each division. For example, setting it to 10mv/div means the range for the entire window is 100mv. Setting it to 1v/div means the range for the entire window is 10v. The knob can be adjusted in three ways:

Method 1: Place the mouse cursor over the knob area and rotate the knob by scrolling the mouse wheel. When the mouse is in other areas, its scroll wheel is used to adjusting the horizontal resolution.

Method 2: Place the mouse cursor over the upper or lower part of the knob and click the left button of mouse to rotate it up or down.

Method 3: Press the shortcut key "0" or "1" to set/cancel the channel focus. When the channel is in focus, press the shortcut key "↑" or "↓" to rotate the knob up or down.

Color: The color of the current channel waveform.

Coupling: Channel coupling mode (DC/AC).

Probe Attenuation: Should be set to match the physical attenuation setting of the probe. If the probe is set to 1x attenuation, select x1; if the probe is set to 10x attenuation, select x10.

Autoset: Automatically adjusts the appropriate Vertical Scale, Horizontal Resolution, and Trigger Level based on the current waveform.

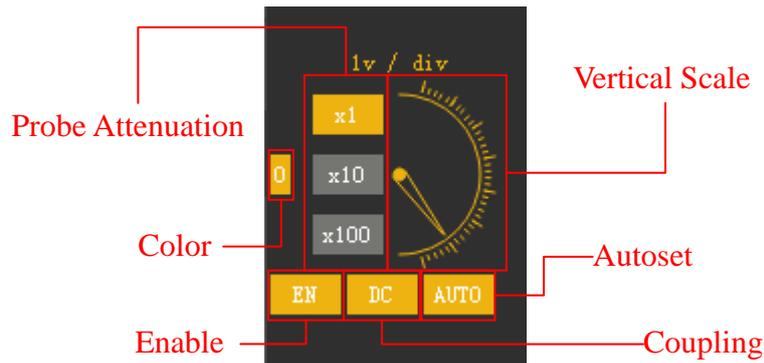

Figure 3-10

As Figure 3-11 shows, you can adjust the Vertical Offset of a channel by holding down the left button of mouse on the Channel Label and moving the mouse. Alternatively, you can also click to select the Channel Label and then move the mouse to adjust the Vertical Offset, and click again to end the adjustment.

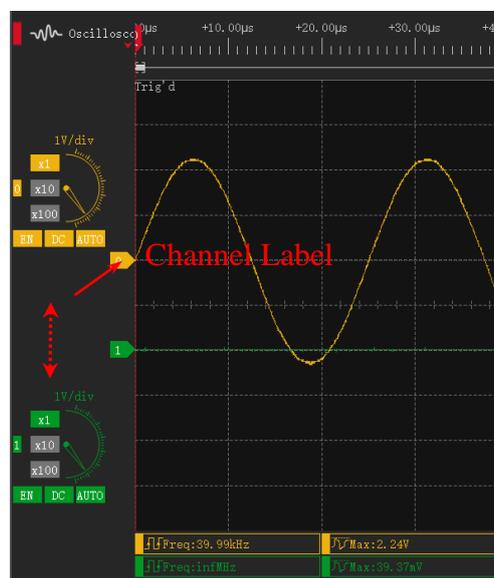

Figure 3-11

3.3.2 Horizontal Resolution

As Figure 3-12 shows, this combobox can be used to set Horizontal Resolution. Additionally, roll the wheel of mouse in wave windows will also change Horizontal Resolution.

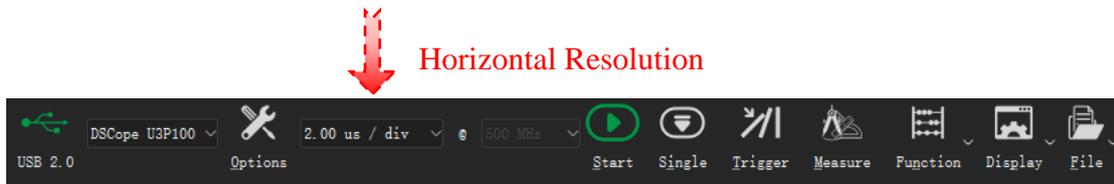

Figure 3-12

3.3.3 Run/Stop

As Figure 3-13 shows, click **Start** button or press the shortcut key "S", oscilloscope will start to capture data and show waveform in real-time, and this button will become **Stop**, click it again will stop running and show the last waveform.

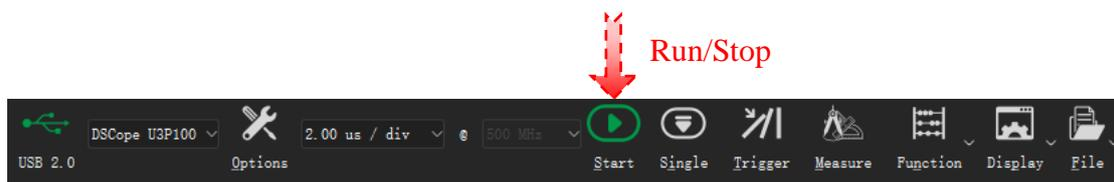

Figure 3-13

3.3.4 Single Capture

As Figure 3-14 shows, click **Single** button or press the shortcut key "I", oscilloscope will capture data once, stop automatically, and show the waveform.

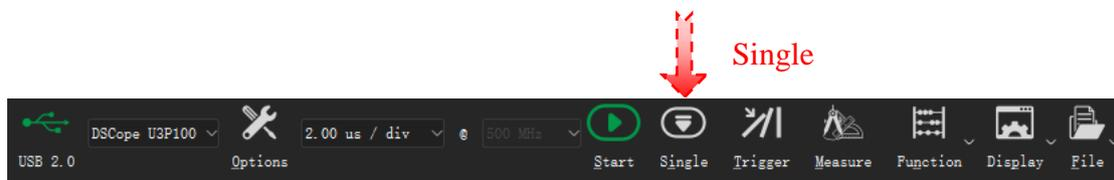

Figure 3-14

3.3.5 Trigger

DSView support simple edge trigger mode, and also support setting of Trigger Level, Trigger Position, Hold Off time and Trigger Sensitivity. Click **Trigger** button or press the shortcut key "T", Trigger Settings dock will be opened. (Figure 3-15).

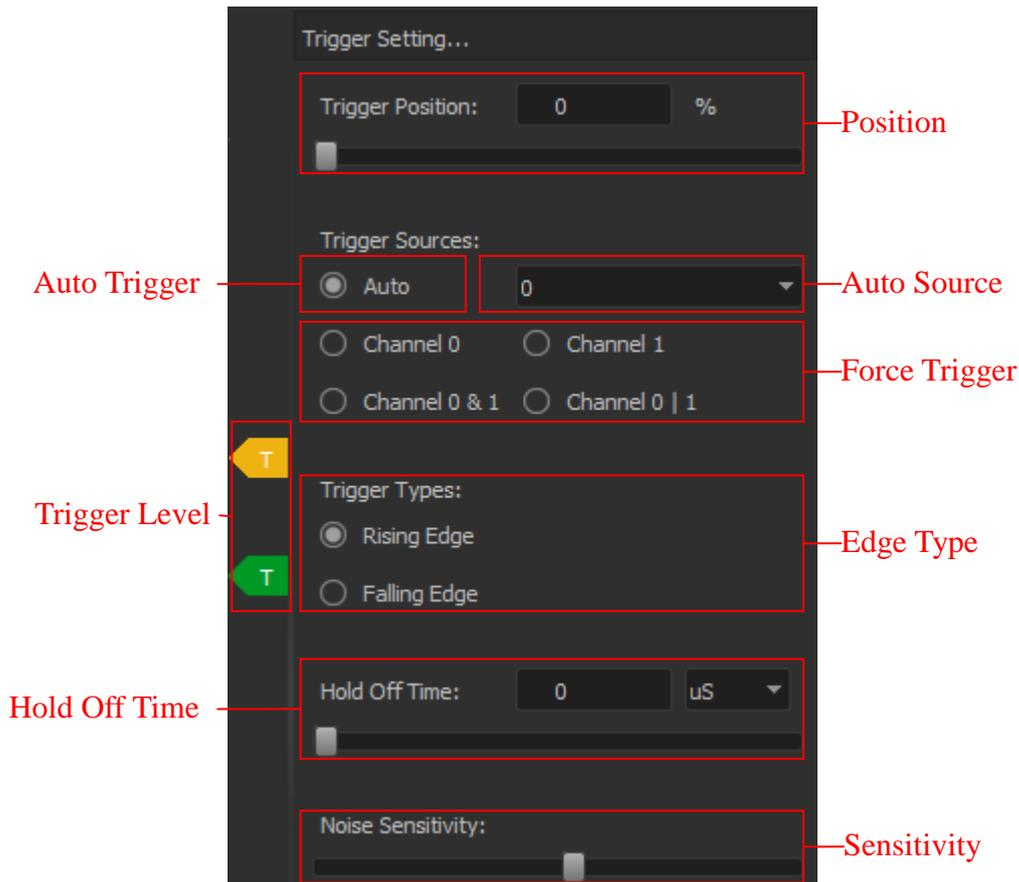

Figure 3-15

Trigger Level: The trigger level determines the triggering voltage, and each channel has a separate trigger level label. To adjust the trigger level, click on the trigger level label corresponding to the channel that needs adjustment, then move the mouse to change the trigger level, and click again to complete the trigger level setting.

Trigger Position: The trigger position determines the percentage position of the trigger point within the entire sampling range. For example, 50% represents the trigger point in the middle of the entire sampled waveform.

Auto Trigger: The auto trigger mode automatically determines whether to set the trigger condition based on the current waveform and trigger level settings. If the trigger voltage is within the waveform area and meets the sensitivity requirements, it will automatically set the specified channel for triggering. If the trigger condition is not met, it will be set as no trigger, and the auto display mode will be activated.

Holdoff Time: The trigger holdoff time can set a period of time after triggering as a prohibited trigger time. For example, setting the time to 10ms means that after triggering, it will wait for at least 10ms before the next trigger. Holdoff time can be used for stable triggering of burst transmission waveforms.

Trigger Sensitivity: The slider on the leftmost position indicates the highest sensitivity, where any voltage change between the trigger levels will trigger. The slider on the rightmost position indicates the lowest sensitivity, where the voltage needs to cross the trigger level within a relatively large range to trigger. This setting can filter out the influence of noise on triggering.

3.4 Measurements

3.4.1 Auto Measurements

DSView supports automatic measurement of 20 parameters, as Figure 3-16 shows. The waveform window has 10 display boxes for measurement results, each of which can show any of the 20 selected parameters.

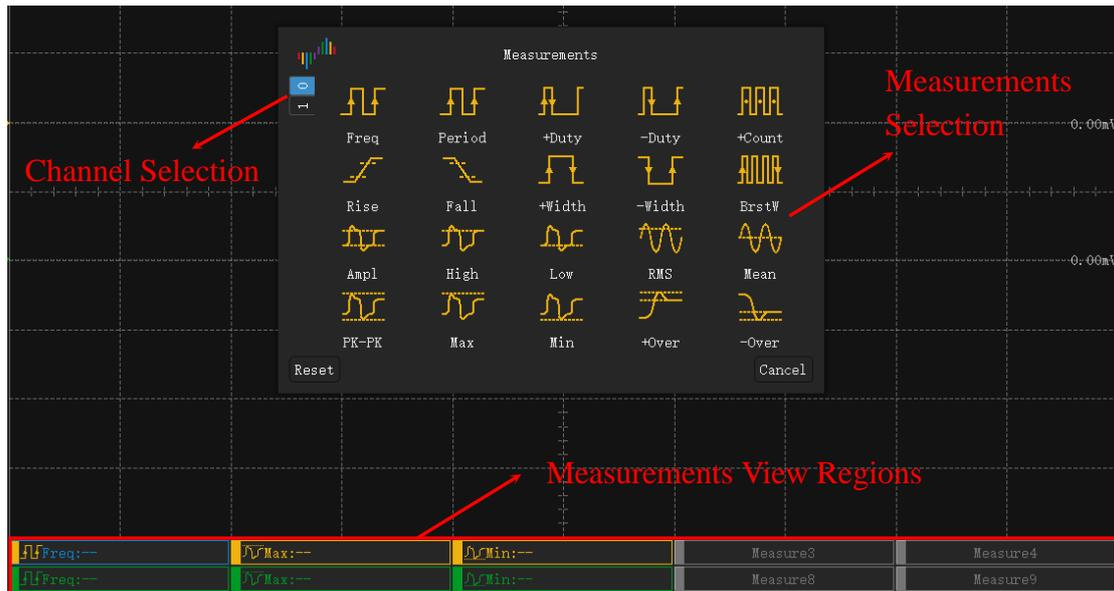

Figure 3-16

The method to set up Auto Measurement :

1. Click on any measurement display box to open the Auto Measurement Selection window.
2. On the left side, select the desired channel for measurement.
3. Click on the specific measurement parameter. If you don't want to change the current selection, you can click the **Cancel** button. If you want to remove the measurement for the display box, click **Reset**.

The current measurement settings will be automatically saved when the software is closed. When you reopen the software and insert the same device, the previous settings will be automatically loaded.

3.4.2 Y Cursors

Cursor Insert:

Method 1: In time ruler area, move the mouse to the desired position where you want to insert a cursor, click the left button of mouse, and an arrow-down region will appear. Within this region, click the left button of mouse again to insert a new cursor.



Figure 3-17

Method 2: In the wave area, click the right button of mouse, and select “Add Y-cursor”.

Cursor Move:

Method 1: Move the mouse to the cursor position. When the cursor is highlighted in bold, click the left button of mouse to select the cursor you want to move. The cursor will then follow the mouse movement.

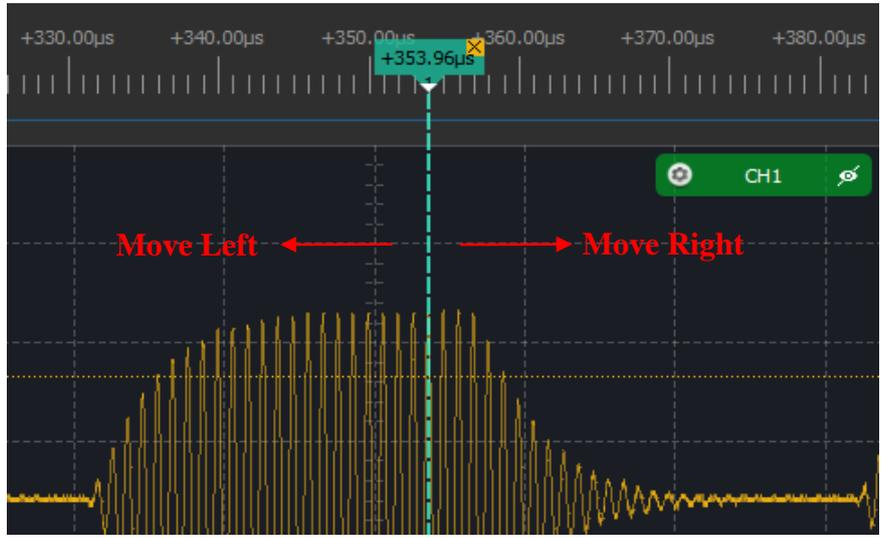

Figure 3-18

Method 2: In time ruler area, move the mouse to any position and click the left button of mouse. This will display the numbers of all existing cursors. Click on any number to move the corresponding cursor to the position indicated by the arrow.

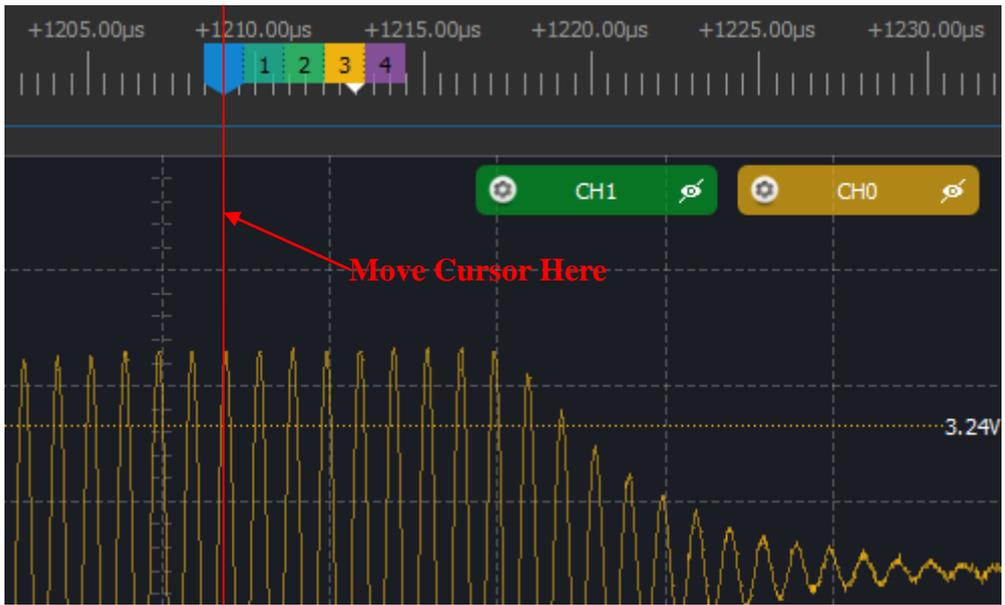

Figure 3-19

Cursor Jump: Cursors can help us mark important positions for easy reference. The following operation allows you to navigate between cursor positions. On the time ruler, click the right button of mouse at any position. This will display the numbers of all existing cursors. Click on any number to navigate to the position of that cursor.

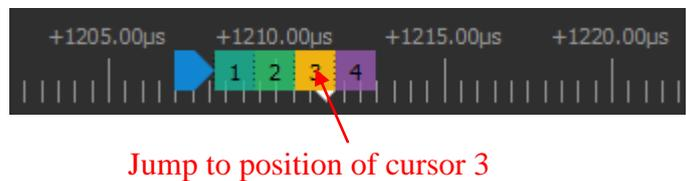

Figure 3-20

Cursor Measurement:

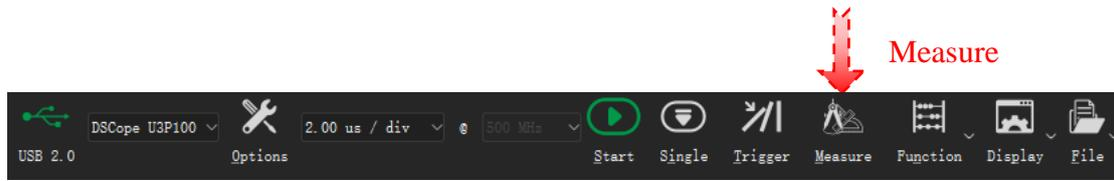

Figure 3-21

As Figure 3-21 shows, Click **Measure** button or press the shortcut key "M", measure dock will be opened. Only the Distance Measure is valid in Oscilloscope mode.

Distance measure: This can be used to measure the time or sample count between two cursors. Click **+** button to add a new set of distance measurement, and then click the start/end area to select the start/end cursor individually.

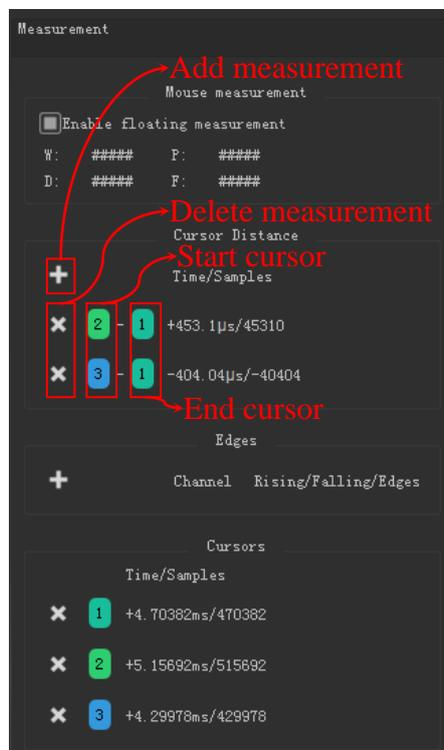

Figure 3-22

Cursor Delete: As Figure 3-23 shows, click the "×" area of any cursor or click the "×" button in front of cursor list in the measure dock will delete the cursor, and remain cursors will be renumbered.

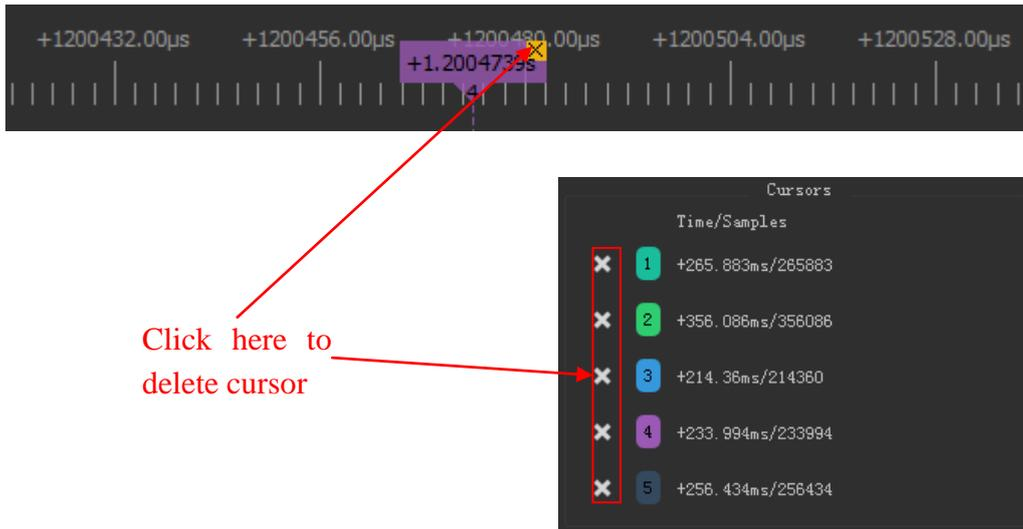

Figure 3-23

3.4.3 X Cursors

As Figure 3-24 show, in the wave area, you can insert an X cursor by clicking the right button of mouse and selecting 'Add X-cursor'. The cursor will be highlighted when the mouse is moved to its position. Clicking the left button of mouse at this point will select the cursor, and you can adjust its position by moving the mouse. Clicking the left button of mouse again will release the cursor.

Each set of X-axis cursors consists of two horizontal lines, and the Δ value in the middle represents the voltage difference of the corresponding channel. Clicking the channel toggle block on the right side of the cursor allows you to switch between different channels. Clicking the \times on the right side of the cursor will delete the current X-axis cursor.

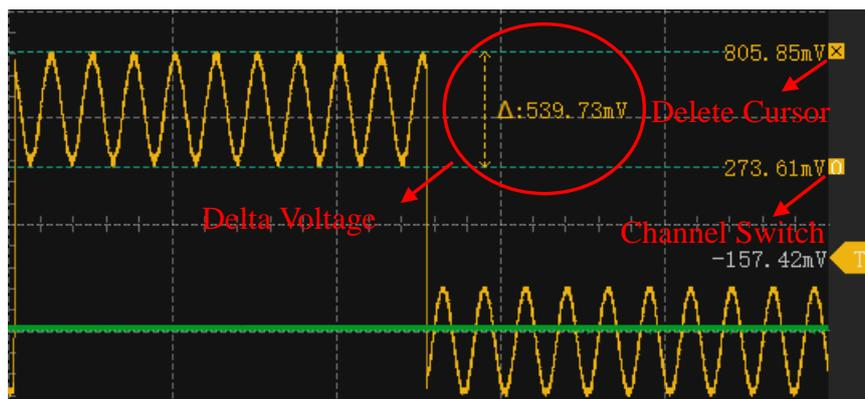

Figure 3-24

3.4.4 Manual Measurement

DSView supports manual measurement using mouse operations, which complements the limitations of automatic measurements. With mouse operations, you can view the voltage value of any sample point in the wave window, and create horizontal measurement rulers.

Current Sample Point: As Figure 3-25 shows, in the stopped capture state, when you move the mouse

cursor over the wave area, the voltage value of the current sample point will be automatically displayed.

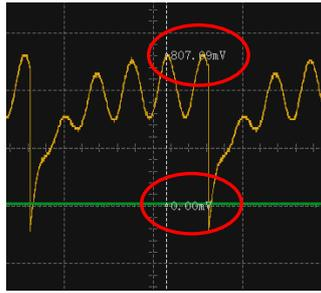

Figure 3-25

Horizontal Measure Ruler: To create a horizontal measurement ruler in the wave window, double-click the left button of mouse in the blank area (measurement starting position). Move the mouse to the next test point, and click the left button of mouse to measure the width of the interval. Move the mouse to the next test point (measurement ending position), and click the left button of mouse to measure the frequency, period, and duty cycle of the entire interval. The measurement results are shown as in Figure 3-26.

Once the measurement is started, you can cancel it by clicking the right button of mouse. To cancel an existing measurement ruler, double-click the left button of mouse in the blank area again.

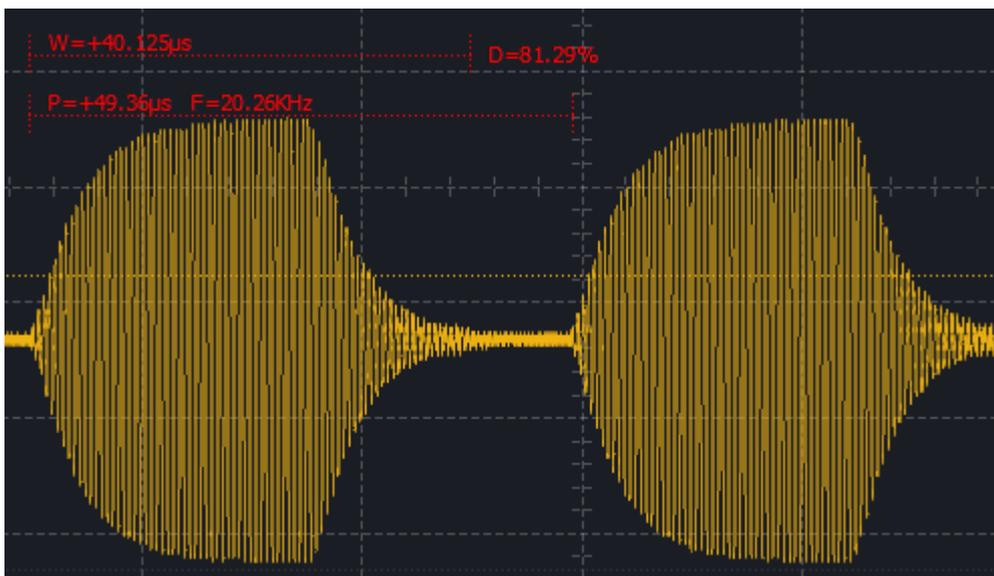

Figure 3-26

3.5 Spectrum Analysis

3.5.1 FFT Options

As Figure 3-27 shows, click **FFT** in **Function** menu, will open **FFT Options** window.

FFT Enable: Enable the spectrum analysis window or not.

FFT Length: Specifies the length of data for FFT analysis. The maximum supported FFT length is 16384 points. The data is taken from the 0 sample. Longer lengths provide higher frequency resolution in the spectrum.

Sample Interval: Adjust the sampling interval to control the data samples used for FFT. Using a larger sampling interval for low-frequency signals reduces the frequency range of the spectrum analysis while

improving the resolution. Be aware of potential frequency aliasing caused by resampling.

FFT Source: Select the channel for spectrum analysis.

FFT Window: Choose the window function to be used for FFT. Currently supported options include Rectangle, Hann, Hamming, Blackman, and Flat-Top windows.

DC Ignored: Determine whether to display the DC component in the spectrum analysis result.

Y-axis Mode: Set the display mode for the Y-axis, which can be either dB or linear.

DBV Range: Set the display range of the Y-axis when using the dB mode.

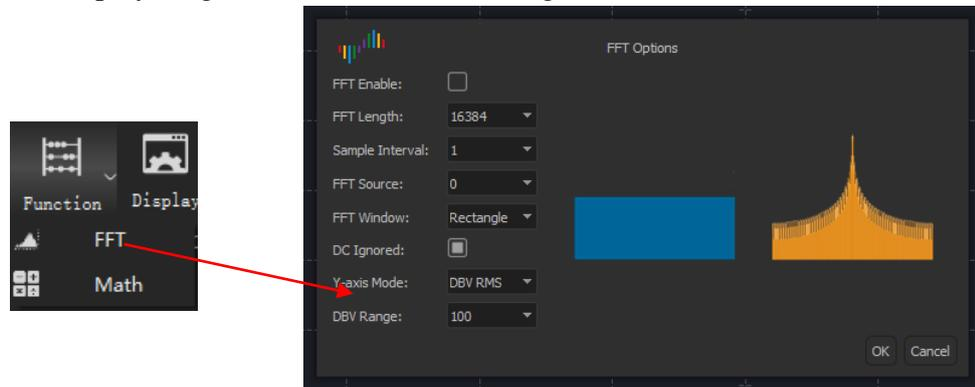

Figure 3-27

3.5.2 Navigating Spectrum

As Figure 3-28 shows, spectrum window display below the wave window.

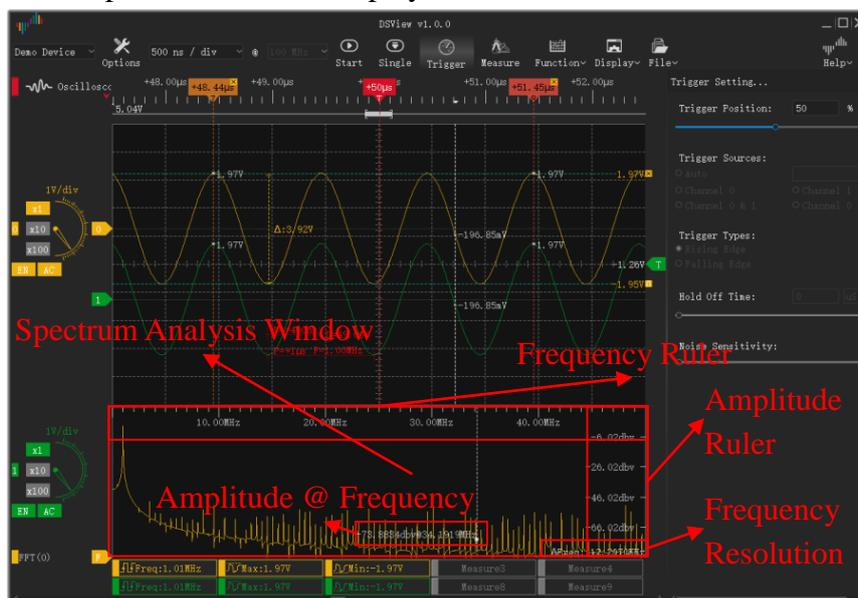

Figure 3-28

Spectrum window support following operations:

Height Adjustment: Place the mouse cursor in the middle of the wave window or the spectrum analysis window, and the mouse cursor shape changes to the one shown in Figure 3-29, press and hold the left button of mouse and move the mouse to change the height of the window.



Figure 3-29

Spectrum Zoom: When the mouse is positioned inside the spectrum analysis window, scrolling the mouse wheel will zoom in or out on the frequency scale, with the mouse cursor as the center point. This allows for observing detailed information about specific frequency points.

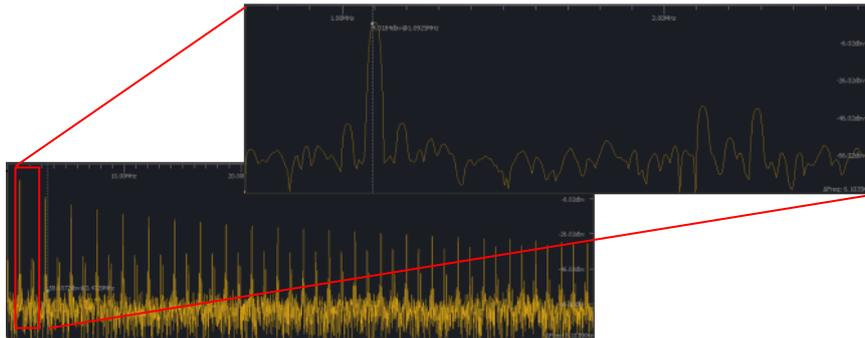

Figure 3-30

Mouse Measurement: As Figure 3-31 shows, moving the mouse inside the spectrum analysis window will show the spectral magnitude and frequency at the mouse cursor position.



Figure 3-31

Window Panning: When zoomed in to examine spectrum details, you can press and hold the left button of mouse and move left or right to drag the spectrum analysis window to the left or right.

3.6 Math Function

DSView's math function supports adding, subtracting, multiplying, and dividing physical channel signals by adding virtual channels.

3.6.1 Add Math Channel

As Figure 3-32 shows, click **Math** in **Function** menu will open **Math Options** window. Check **Enable** checkbox to enable/disable math channel.

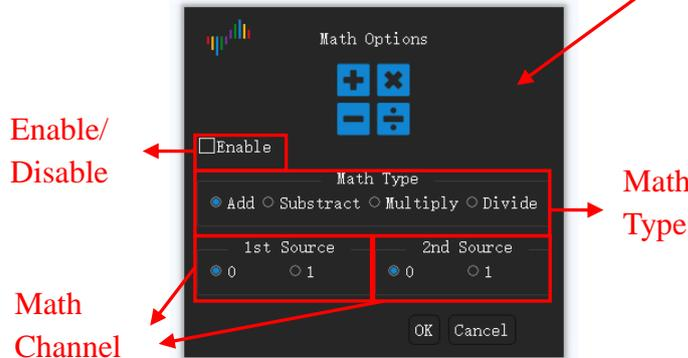
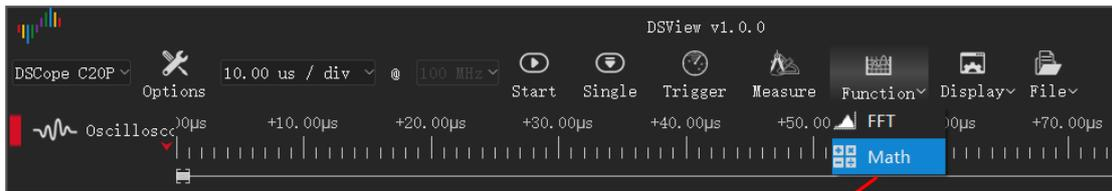

Figure 3-32

3.6.2 Math channel

As Figure 3-33 shows, when adding a math channel, it is set to the default Vertical Scale. Similar to physical channels, you can change the Vertical Scale by using the dial. Additionally, you can customize the channel color and adjust the Vertical Offset by dragging the Channel Label.

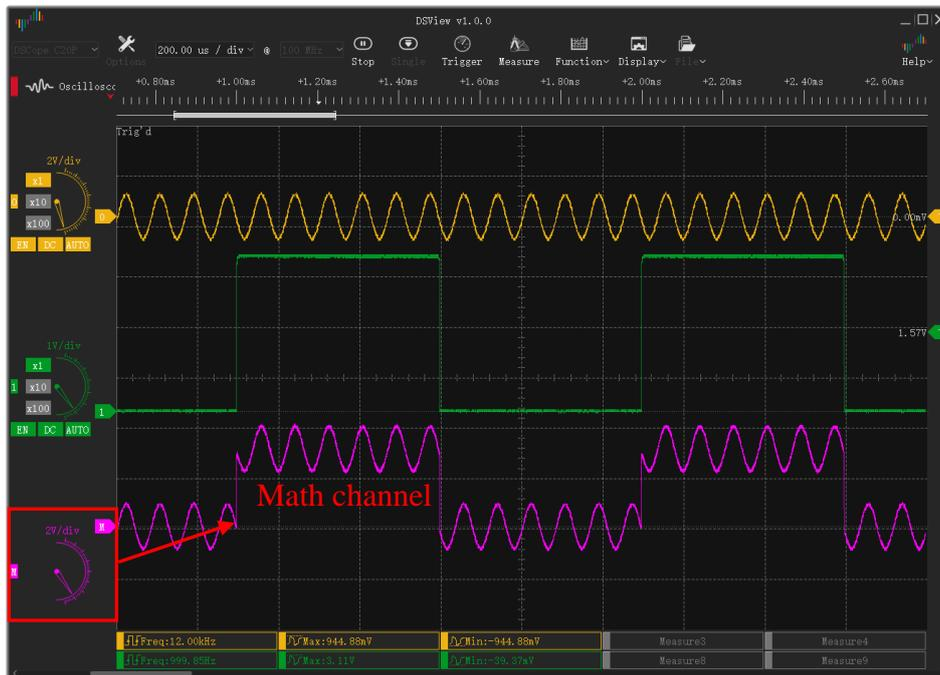

Figure 3-33

3.7 Lissajous Figure

3.7.1 Lissajous Setup

As Figure 3-34 shows, click **Lissajous** in **Display** menu will open the **Lissajous Options** window.

Check **Enable** checkbox, select x-axis source and y-axis source, and then click **OK** button, Lissajous Figure will be opened.

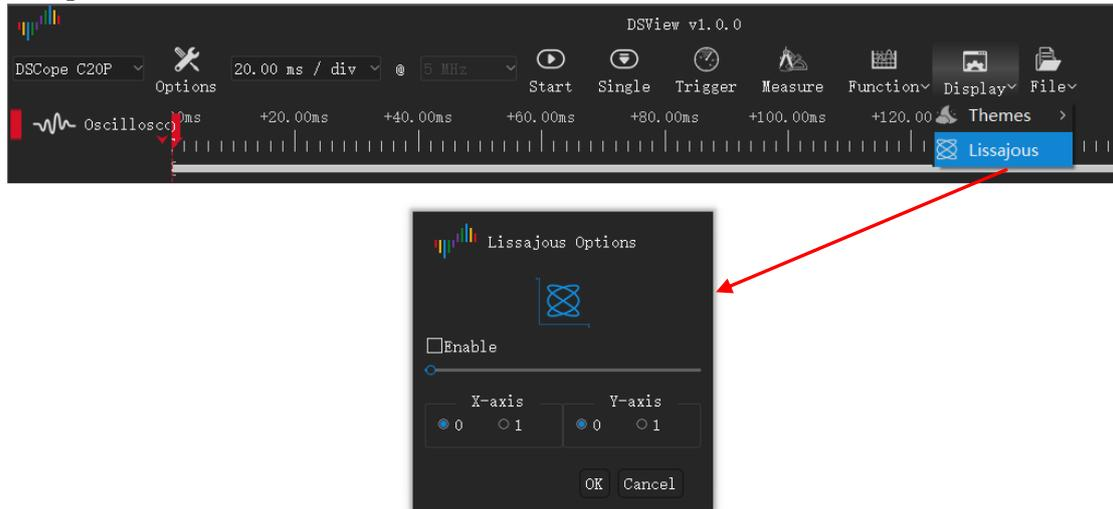

Figure 3-34

3.7.2 Lissajous View

Figure 3-35 shows the effect of Lissajous Figure.

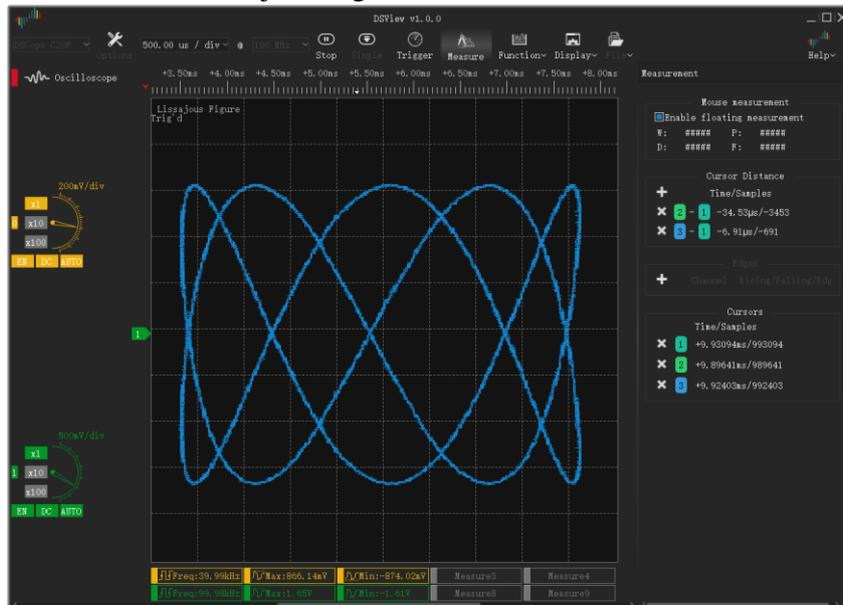

Figure 3-35

3.8 File Operations

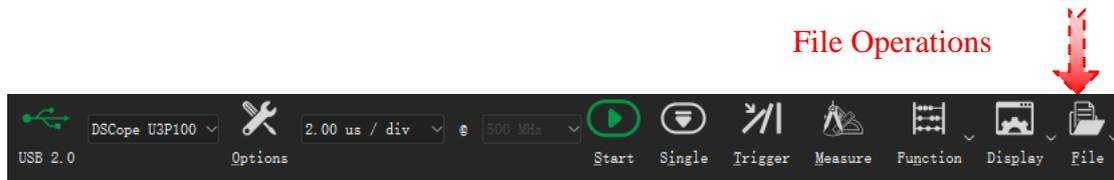

Figure 3-36

Click the **File** button will bring up the menu for file-related operations, as Figure 3-37 shows. DSView supports file operations such as session load/save, data saving/opening, data export, screenshot, and more.

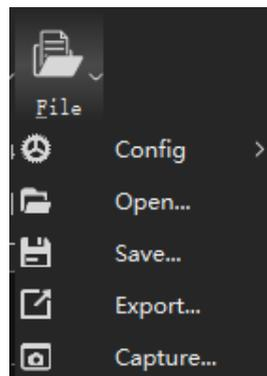

Figure 3-37

3.8.1 Load/Save Session

Session represents the current settings, including device options, channel enable/disable, colors, names, and trigger settings. Select **Config > Save Session** to save the current settings to a file. To import a specific configuration, select **Config > Load Session** and choose the corresponding configuration file.

By selecting **Config > Load Default Session**, you can load the default settings, which restore the device to its factory default condition. DSView also supports automatic saving and loading of configurations. When you reopen the software, it will automatically load the settings from the previous session before it was closed.

3.8.2 Save

Click **File > Save** and set the desired file path and name to save the current data in a file format that can be parsed by DSView for later opening and viewing.

3.8.3 Open

Click **File > Open** and select the data file you want to load. The data will be reloaded and displayed in the wave window. DSView only supports opening files with the .dsl file extension.

3.8.4 Export

DSView supports exporting the current data to common file formats for use in other software. In Oscilloscope mode, you can click on **File > Export** to export the current data. Currently, exporting in CSV format is supported.

3.8.5 Screen Shot

If you want to save the current screen as an image, you can choose the screenshot operation. Click **File > Capture**, and it will save the current screen as a PNG file.

4 Data Acquisition

4.1 Hardware Connection

The Oscilloscope mode is suitable for observing periodic waveforms or capturing specific waveform anomalies, but it is not suitable for continuous long-term observation of irregular signal changes, such as voltage monitoring or power consumption monitoring, etc. On the other hand, the Data Acquisition mode is specifically designed for long-term capture of irregular signals. It allows flexible settings for the desired Sample Rate and Sample Duration.

The hardware that currently supports the Data Acquisition mode is the DSCope series Oscilloscope. The hardware connection for the Data Acquisition mode is identical to the one described in the hardware connection section of Section 3.1. After connecting the hardware as shown in Figure 4-1, you can select the Data Acquisition mode to use it.



Figure 4-1

4.2 Hardware Options

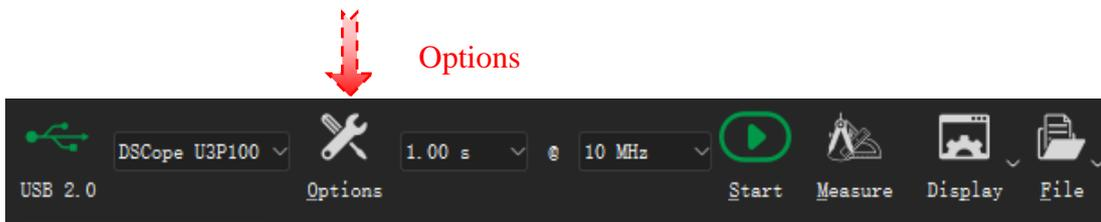

Figure 4-2

Under Data Acquisition mode, click **Options** menu (Figure 4-2) or press the shortcut key "O", **Device Options** window will pop up, as Figure 4-3 shows.

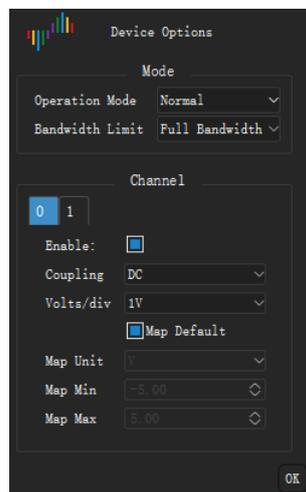

Figure 4-3

4.2.1 Operation Mode/ Bandwidth Limit

- **Operation Mode:**
 - **Normal:** Normal working
 - **Internal Test:** Test only.
- **Bandwidth Limit:**
 - **Full Bandwidth:** No limit.
 - **20Mhz:** Limit to 20MHz

4.2.2 Channel Options

In the Data Acquisition mode, the parameters of the channels need to be set before the acquisition begins, and these parameters cannot be modified during the acquisition process. Please refer to Figure 4-4 for more details.

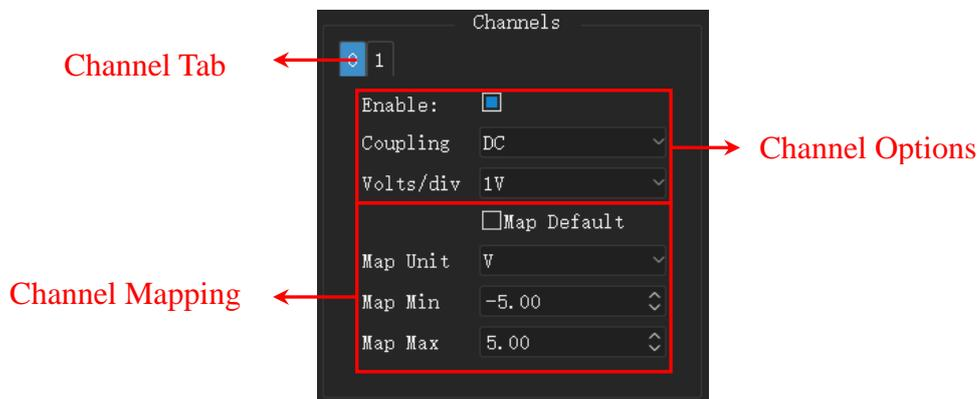

Figure 4-4

Enable: Turn on/off the channel.

Coupling: Set the channel as DC or AC coupling.

Volts/Div: Vertical resolution setting, representing voltage values per division.

Map Default: Default physical quantity in the vertical direction, usually the actual voltage value.

Map Unit: Maps voltage values to other physical quantities. Such as current, temperature, weight, speed, etc.

Map Min: Minimum value of the corresponding physical quantity.

Map Max: Maximum value of the corresponding physical quantity.

For most sensors, the corresponding physical quantity is converted into voltage or current values, which are then detected and collected by the measurement system. Therefore, the vertical axis mapping function can conveniently restore the voltage waveform to the corresponding physical quantity value, making the collected waveform more intuitive.

For DScope series oscilloscope devices operating in Data Acquisition mode, they share the same calibration system as the oscilloscope mode. So, if there is a vertical offset in the channel in Data Acquisition mode, you can recalibrate it in the oscilloscope mode.

4.3 Capture

4.3.1 Capture Option

In Data Acquisition mode, you can set the Sample Rate and Sample Duration according to your needs. The maximum Sample Duration varies depending on the chosen Sample Rate. For example, at the highest Sample Rate of 10M, you can capture up to 10 seconds of data. At a Sample Rate of 1K, you can capture data for a whole day.



Figure 4-5

4.3.2 Start/Stop

After completing the channel and capture settings, you can click on the **Start** button or press the shortcut key "S" to begin waveform acquisition. During the acquisition process, the **Start** button will change to a **Stop** button. Before clicking the **Stop** button, the waveform will continuously update and be displayed in real-time.

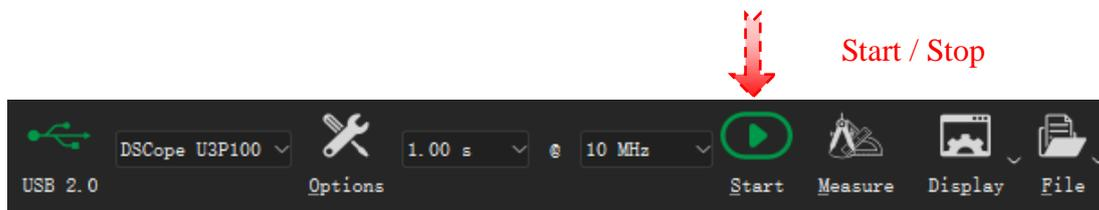

Figure 4-6

4.4 Measurement

4.4.1 Cursor Measure

Cursor insertion: In time ruler area, move the mouse to the desired position where you want to insert a cursor, click the left button of mouse, and an arrow-down region will appear. Within this region, click the left button of mouse again to insert a new cursor.

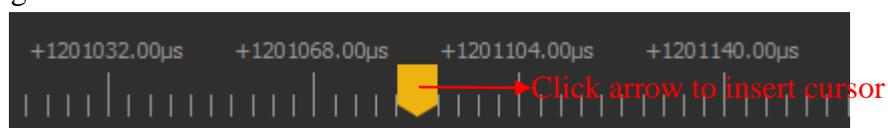

Figure 4-7

Cursor movement:

Method 1: Move the mouse to the cursor position. When the cursor is highlighted in bold, click the left button of mouse to select the cursor you want to move. The cursor will then follow the mouse movement.

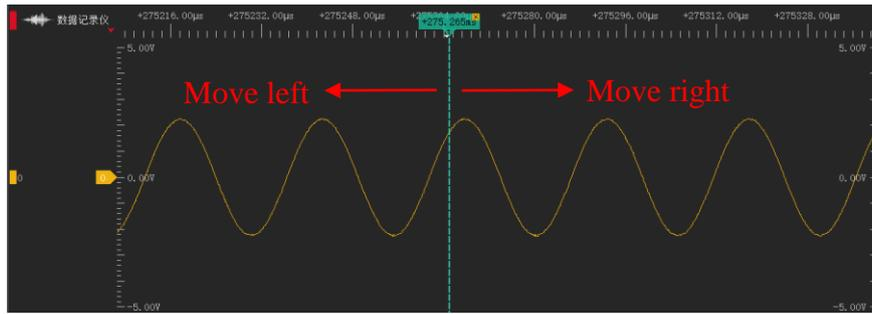

Figure 4-8

Method 2: In time ruler area, move the mouse to any position and click the left button of mouse. This will display the numbers of all existing cursors. Click on any number to move the corresponding cursor to the position indicated by the arrow.

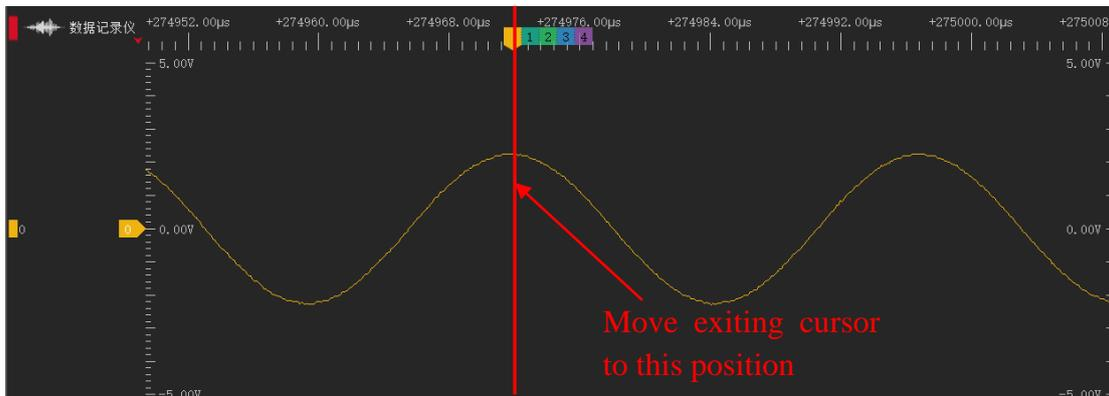

Figure 4-9

Cursor Jump: Cursors can help us mark important positions for easy reference. The following operation allows you to navigate between cursor positions. On the time ruler, click the right button of mouse at any position. This will display the numbers of all existing cursors. Click on any number to navigate to the position of that cursor.

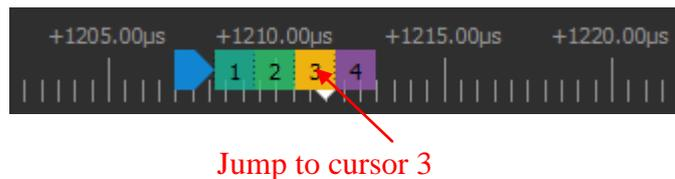

Figure 4-10

Cursor Measure:

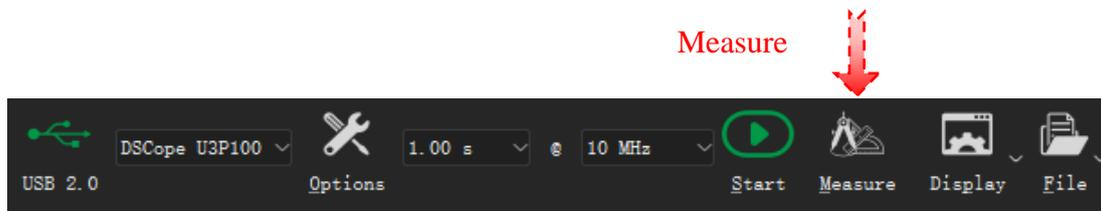

Figure 4-11

As Figure 4-11 shows, Click **Measure** button or press the shortcut key "M", measure dock will be opened. Only the distance measure is valid in Data Acquisition mode.

Distance measure: This can be used to measure the time or sample count between two cursors. Click **+** button to add a new set of distance measurement, and then click the start/end area to select the start/end

cursor individually.

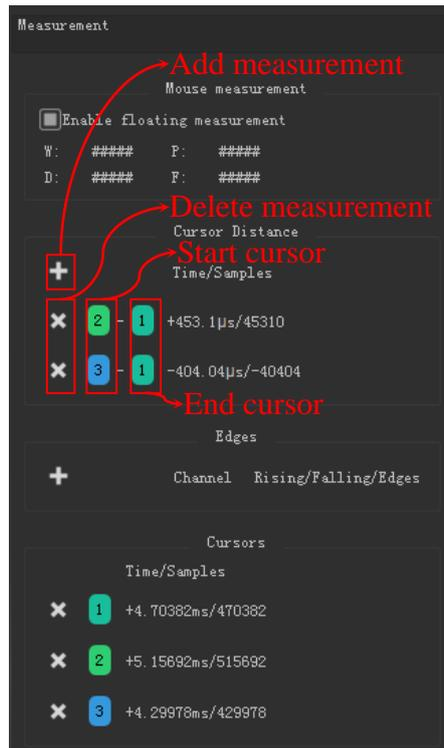

Figure 4-12

Cursor Delete: As Figure 4-13 shows, click the "×" area of any cursor or click the "×" button in front of cursor list in the measure dock will delete the cursor, and remain cursors will be renumbered.

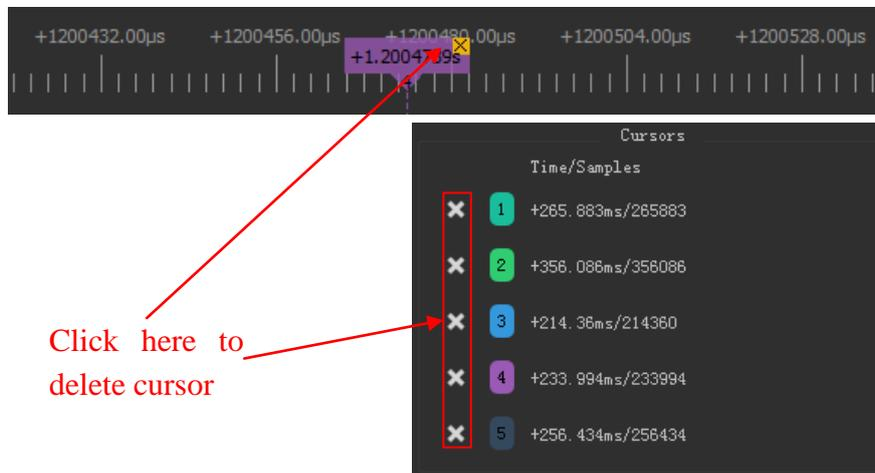

Figure 4-13

4.4.2 Manual Measurement

DSView supports manual measurement using mouse operations. With mouse operations, you can view the voltage value of any sample point in the wave window.

Current Sample Point: In the stopped capture state, when you move the mouse cursor over the wave area, the voltage value of the current sample point will be automatically displayed.

4.5 File Operations



Figure 4-14

Click the **File** button will bring up the menu for file-related operations, as Figure 4-15 shows. DSView supports session load/save, data saving/opening, data export, screenshot, and more.

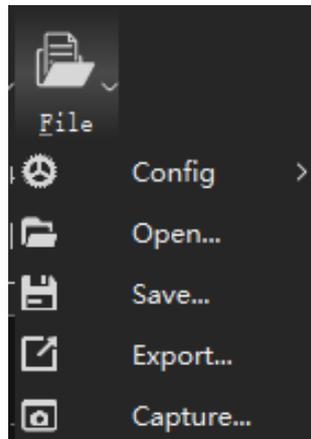

Figure 4-15

4.5.1 Load/Save Session

Session represents the current settings, including device options, channel enable/disable, colors, names, and trigger settings. Select **Config > Save Session** to save the current settings to a file. To import a specific configuration, select **Config > Load Session** and choose the corresponding configuration file.

By selecting **Config > Load Default Session**, you can load the default settings, which restore the device to its factory default condition. DSView also supports automatic saving and loading of configurations. When you reopen the software, it will automatically load the settings from the previous session before it was closed.

4.5.2 Save

Click **File > Save** and set the desired file path and name to save the current data in a file format that can be parsed by DSView for later opening and viewing.

4.5.3 Open

Click **File > Open** and select the data file you want to load. The data will be reloaded and displayed in the wave window. DSView only supports opening files with the .dsl file extension.

4.5.4 Export

DSView supports exporting the current data to common file formats for use in other software. In Data Acquisition mode, you can click on **File > Export** to export the current data. Currently, exporting in CSV format is supported.

4.5.5 Screen Shot

If you want to save the current screen as an image, you can choose the screenshot operation. Click **File > Capture**, and it will save the current screen as a PNG file.